

**bPlus-U2**

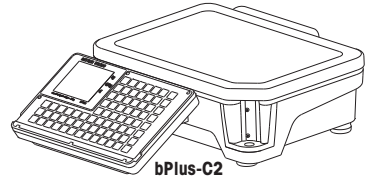

**bPlus-C2**

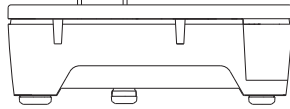
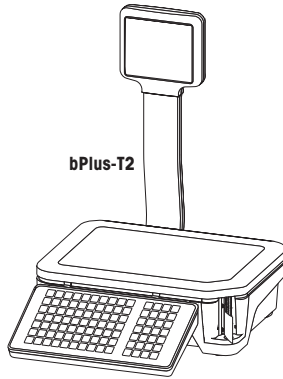

**bPlus-T2**

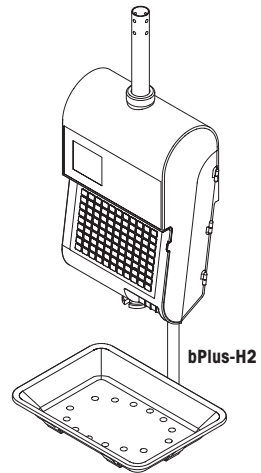

**bPlus-H2**



# Table of Contents

<b>1</b>	<b>Your new retail scale</b>	<b>5</b>
1.1	Most important functions .....	5
1.2	Safety instructions .....	5
1.3	Further documents .....	5
1.4	Maintenance .....	5
1.5	Intended use .....	5
1.6	Conventions and symbols used in this user manual.....	6
1.7	Device overview.....	7
1.7.1	Display .....	7
1.7.2	Keyboard .....	8
1.7.3	Function keys .....	10
1.7.4	Connections .....	11
1.8	Legal for trade .....	11
1.9	Fiscal regulations.....	11
<b>2</b>	<b>Setup and device settings</b>	<b>12</b>
2.1	Contents .....	12
2.2	Requirements for scale's location.....	12
2.3	Levelling the scale* .....	12
2.4	Mounting the tower* .....	13
2.5	Hanging up the scale* .....	14
2.6	Inserting paper with bPlus-U2, bPlus-C2 and bPlus-T2 .....	16
2.6.1	Paper format.....	16
2.6.2	Opening the scale .....	16
2.6.3	Inserting the ticket roll .....	17
2.6.4	Inserting the label roll .....	18
2.6.5	Inserting the linerless label roll .....	19
2.7	Inserting paper with bPlus-H2 .....	20
2.7.1	Paper format.....	20
2.7.2	Opening the scale .....	21
2.7.3	Inserting the ticket roll .....	22
2.7.4	Inserting the label roll .....	22
2.8	Connecting to mains power.....	23
2.9	Turning on .....	23
2.10	Restart / Shutdown .....	23
2.11	Setting up the network .....	24
2.11.1	Network identification icon.....	24
2.11.2	Wireless network (option) .....	24
2.12	Cleaning .....	25
2.13	Disposal .....	26
<b>3</b>	<b>Fast and easy operation</b>	<b>27</b>
3.1	Log in / log out.....	27
3.2	Free input.....	28
3.2.1	Free input in sales mode .....	28
3.2.2	Free input in pre-packing mode.....	28
3.3	Working with PLUs.....	29
3.3.1	Calling up a PLU .....	29
3.3.2	Calling up a PLU with preset keys .....	29
3.4	Using quantity PLUs and multiplication.....	30
3.5	Taring.....	30
3.5.1	Taring a container .....	30
3.5.2	Manual tare .....	31

3.5.3	Customer tare / Basket function.....	31
3.5.4	Multiple preset tare .....	32
3.5.5	Default primary tare .....	32
3.6	Zeroing .....	32
3.7	Large quantities .....	33
3.8	Weighing with 100 g price unit .....	33
3.9	Working with several vendors.....	34
3.9.1	Working with several vendors on one scale (multiple vendor)*.....	34
3.9.2	Working with one vendor on one scale (single vendor key).....	34
3.9.3	Working with several scales (floating vendor) .....	35
3.10	Printing options .....	36
3.10.1	Setup printing (ticket, label, linerless, endless) .....	36
3.10.2	Printing a copy of the ticket .....	36
3.10.3	Total label / Basket total label .....	37
3.10.4	Printing total labels using the total label key .....	38
3.10.5	Batch printing .....	39
3.11	Voiding.....	39
3.12	Refunding .....	40
3.13	Suspending.....	40
3.14	Reopening a ticket .....	41
3.15	Changing prices .....	41
3.15.1	Overwriting a price temporarily.....	41
3.15.2	Overwriting a price permanently .....	42
3.15.3	Changing to another price .....	42
3.16	Granting discounts.....	43
3.16.1	Granting a discount on a single item .....	43
3.16.2	Granting a discount on the total sum .....	43
3.16.3	Granting a pre-defined discount .....	44
3.17	Payment.....	44
3.17.1	Working with return .....	44
3.17.2	Working with multiple payment.....	45
3.18	Cash in / cash out .....	45
3.19	Working with VATs .....	45
3.19.1	Assigning a group VAT.....	45
3.20	Traceability .....	46
3.21	Backup / restoring data via USB device.....	48
3.22	Temporary changes .....	49
3.22.1	Changing the date temporarily .....	49
3.22.2	Changing the label format temporarily .....	49
3.22.3	Changing the extra text temporarily.....	50
3.22.4	Changing the department temporarily .....	50
<b>4</b>	<b>Menu</b> .....	<b>51</b>
4.1	Menu operation .....	51
4.1.1	Entering the menu .....	51
4.1.2	Key functions in the menu .....	51
4.1.3	Navigating in the menu.....	51
4.1.4	Ending the menu.....	52
4.1.5	Text input .....	52
4.1.5.1	Text input via numeric keys .....	52
4.1.5.2	Text input via preset keys*.....	53
4.2	Menu description .....	55
4.2.1	Overview .....	55
4.2.2	Data menu .....	58
4.2.3	Configuration menu .....	65

4.2.4	Reports menu .....	80
4.2.5	Mode menu .....	82
4.2.6	Advanced menu .....	83
4.3	Configuration tips.....	84
4.3.1	Tips for setting up and configuring PLUs .....	84
4.3.2	Setting up vendor groups .....	84
4.3.3	Example for creating a PLU .....	85
4.3.4	Setting up a staggered price .....	86
4.3.5	Setting up a barcode.....	87
4.3.6	Label printing.....	89
4.3.7	Setting up the keyboard.....	89
4.3.8	Setting up a scale network with data synchronization .....	93
4.3.9	Connecting the scale to a network or a computer .....	93
4.3.10	Setting up reports .....	94
4.3.10.1	Setting up basic reports.....	94
4.3.10.2	Setting up combination reports.....	95
4.3.10.3	Sales journal .....	95
4.3.11	Setting up scale mode .....	96
4.3.12	Training function .....	97
<b>5</b>	<b>What to do, if ...?</b>	<b>98</b>
<b>6</b>	<b>Technical data</b>	<b>104</b>
6.1	bPlus-U2 .....	104
6.2	bPlus-C2 .....	105
6.3	bPlus-T2.....	106
6.4	bPlus-H2 .....	106
6.5	Compliance.....	107
6.6	Options/Accessories .....	107



# 1 Your new retail scale

## 1.1 Most important functions

Congratulations on your new scale. This robust scale with its integrated label printer facilitates comfortable pre-packing and selling while maintaining the highest accuracy.

Your new scale not only stands out due to its pre-packing features, but also due to its network-capability and fast data transfer to and from a computer. This lets you, for example, operate integrated scales quickly and allows you to create sales reports easily.

### Note

This manual covers the full spectrum of bPlus variants. Depending on the country and the bPlus model you have chosen, the configuration and functionalities of the scale as well as the availability of menus can vary. For more information, please contact your sales representative.

## 1.2 Safety instructions

### Basic safety instructions

- Read these operating instructions prior to using your scale.
- Follow these operating instructions carefully.
- Store these operating instructions near the scale for future reference.
- Do not allow untrained personnel to operate or to clean the scale.
- Do not open the scale.
- Always unplug the scale before cleaning and maintenance.

## 1.3 Further documents

For further documents regarding your new retail scale (e.g. Guides, Data Sheet) please refer to the following website:

<http://www.mt.com/retail-manuals>

## 1.4 Maintenance

- Only authorized personnel is allowed to open and repair the scale. Please contact your local representative.

## 1.5 Intended use

- Use the scale only for weighing in accordance with this manual.
- The scale is intended for indoor use only.
- Use the scale in dry locations only.
- Any other type of use and operation beyond the limits of the technical specifications is considered as not intended.

### Misuse

- Do not use the scale in industrial and harsh environment.

## 1.6 Conventions and symbols used in this user manual

Symbol	Description
	Safety sign that warns the user of situations resulting in death, serious injury or material damage, in case of non-compliance with the indicated safety advices.
<b>i</b>	General information that makes working with the device easier.
<b>C</b>	Configuration requirements and tips.
■	Precondition for an action.
-	Individual action that must be carried out.
1 2	Action sequence that must be carried out in the order stated.
⇒	Result of an action or an action sequence.
[▶ 18]	Cross-reference (example: reference to page 18)
System is restarting	<ul style="list-style-type: none"> <li>• Message on the scale's display</li> <li>• Menu or sub-menu name</li> </ul>
[Save Price] key	Preset key on the scale's keyboard
"Void"	Setting in a menu/sub-menu



## 1.7 Device overview

### 1.7.1 Display

The display is laid out as follows, seen both from the customer and the vendor point of view:

- 1 Weight display
- 2 Unit price
- 3 Price
- 4 Field for instructions or status messages
- 5 Metrological information

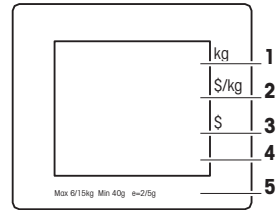

In addition to the weight and price, the following status messages and indicators can be displayed:

- 0← Gross weight is zero
- NET** Net weight
- 100g** Price per 100 g
- X** Quantity mode
- PLU** PLU number is displayed
- FIX** PLU or tare is fixed
- LS** Large sale mode
- ⚡ Connected to mains power supply
- 📶 Network/communication status

#### Magnetic points on the customer side of bPlus-H2

On the customer side of bPlus-H2, below the display, you will find 6 magnetic points to attach advertisement.

### 1.7.2 Keyboard

The keyboard is divided into three sections.

In addition to their main function, some function keys have one or more auxiliary functions.

#### bPlus-U2 / bPlus-C2

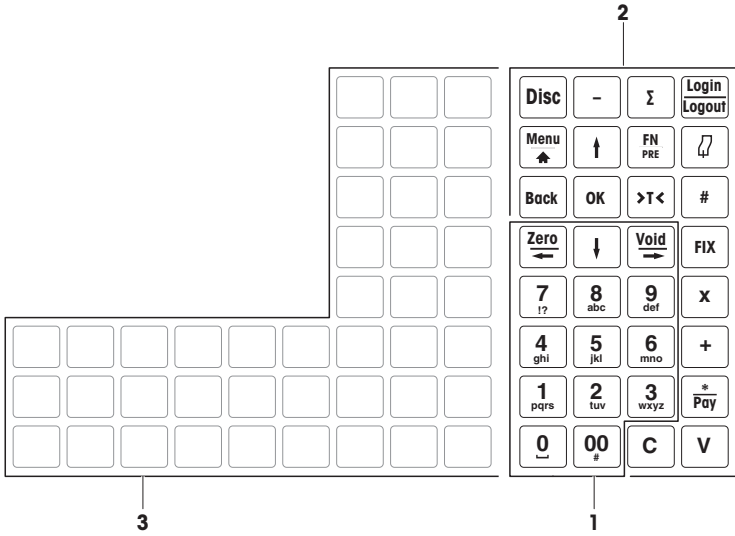

#### bPlus-T2

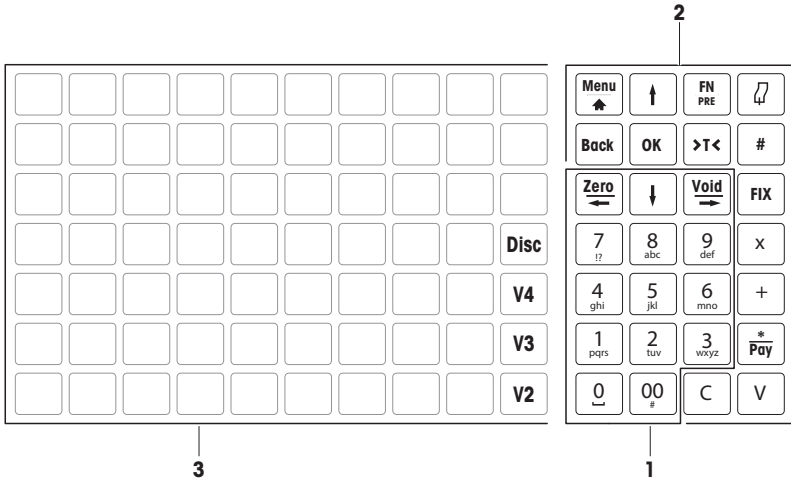



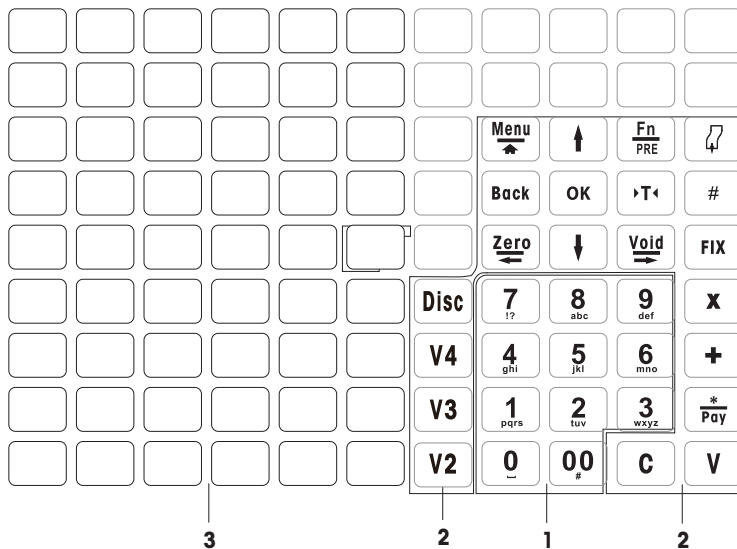



















**bPlus-H2**



- 1 Number keys
- 2 Function keys

- 3 Preset keys

### 1.7.3 Function keys

Key	Name	Function
	Discount key	Enter the discount in percent or absolute value
	Minus key	Access negative price entry (not with bPlus-H2)
	Total label key	Directly enter total label function in prepacking mode (not with bPlus-H2)
	Login / Logout key	Enter the vendor assignment menu (not with bPlus-H2)
	Menu key	<ul style="list-style-type: none"> <li>Enter the menu</li> <li>Press and hold or double click to quickly return to the weighing mode</li> </ul>
	Arrow up key	Go to previous item
	Function key Pre-pack key	Access to further/favorite preset keys Press and hold to change the current mode to pre-pack mode (or back)
	Paper feed key	Feed the paper out of the printer
	Back key	Go back to next higher level in the menu
	OK key	Confirm selection
	Tare key	Tare the scale
	Switch key	Switch between entering the price by PLU number and directly entering the unit price
	Zero key	Zeroing
	Left key	Go to left item
	Arrow down key	Go to next item
	Void key	Cancel the item
	Right key	Go to right item
	Fix key	Fix PLU or tare
	Quantity key	Enter quantity
	Plus key	Enter number for piece articles
	Star key	Subtotal items or close payment
	Vendor key	Book items to Vendor V1.
	Clear key	Confirm item entry, call up label or close payment Clear all the entries

### 1.7.4 Connections

The following connections are located on the bottom side of the scale:

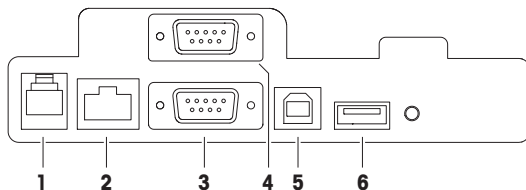

- |   |   |   |   |
|---|---|---|---|
| 1 | Cash drawer connection<br>(availability depending on the country) | 4 | RS-232/COM B, for a scanner or computer |
| 2 | LAN, to set up a network of scales                                | 5 | USB Slave, to connect the PC            |
| 3 | RS-232/COM A, for a scanner or computer                           | 6 | USB, to connect a USB stick             |

### 1.8 Legal for trade

When the scale is used in trade or a legally controlled application, it must be set up, verified and sealed in accordance with local weights and measures regulations. It is the responsibility of the purchaser to ensure that all pertinent legal requirements are met. As verification requirements vary by jurisdiction, the purchaser should contact their local weights and measures office if they are not familiar with the requirements.

The verification process must be performed at the place of use, except for products sold in Europe.

For products sold in Europe, the verification process has been completed at the place of manufacture. These products have been sealed and the type plate includes supplemental metrology markings. They may be put into service immediately. If required by local W & M authorities, additional stickers will already be applied on the device.

For products sold in other regions, the verification process must be performed at the place of use.

To prevent access to calibration and metrological settings, the scale must be sealed using a paper seal or wire seal.

#### Metrological information

Scales that have been factory-calibrated have a label indicating this on the packaging.

Scales with a green M on the type plate are ready for operation.



Scales that are calibrated in two stages have a label indicating this on the packaging.

These scales have only been calibrated in a first stage (Declaration of conformity in accordance with 2014/23/EC directive). The second stage of the calibration must be done on-site by authorized service personnel. Please contact your local representative.



**I** Medium accuracy scales that are used in commerce where certified calibration is required must be calibrated and certified.

Observe the respective measurement data guidelines in your country.

### 1.9 Fiscal regulations

In some countries fiscal regulations may apply. Please contact your local fiscal authorities if you are not familiar with the requirements.

If fiscal regulations are applicable in the country of receipt, a fiscal guide is part of the delivery. Please refer to this guide for further user guidance.

**I** In order to follow the fiscal regulations the following is mandatory:

- Day and time must be set correctly, see sub-menu F274.
- Name and address of the company must be defined correctly; please refer to the local fiscal guide.

## 2 Setup and device settings



Setup depends on your individual device type (bPlus-U2, bPlus-C2, bPlus-T2 or bPlus-H2).

### 2.1 Contents

Check that the delivery is complete:

- Scale
- Tower (bPlus-T2 only)
- Stainless steel weighing pan
- Power cable
- Manual

### 2.2 Requirements for scale's location

The right location is critical to weighing accuracy.

#### Conditions for an ideal location:

- No shocks and vibrations
- No excessive temperature fluctuations
- No direct sunlight
- No strong drafts
- Select a stable, vibration-free and preferably horizontal location for your scale.

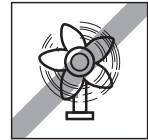
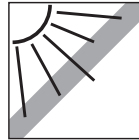
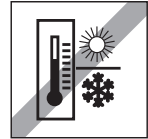
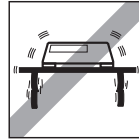

### 2.3 Levelling the scale\*

\* For bPlus-H2, levelling the scale is not required.

Only a perfectly levelled scale delivers accurate weighing results. The scale is equipped with a level indicator to make it easier to level the scale.

- To level the scale, turn the scale's adjustable feet until the air bubble in the level indicator is positioned in the inner circle.

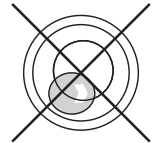
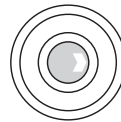

## 2.4 Mounting the tower\*

\* The tower is only available for bPlus-T2.

The tower has to be mounted as display for operator and customer.

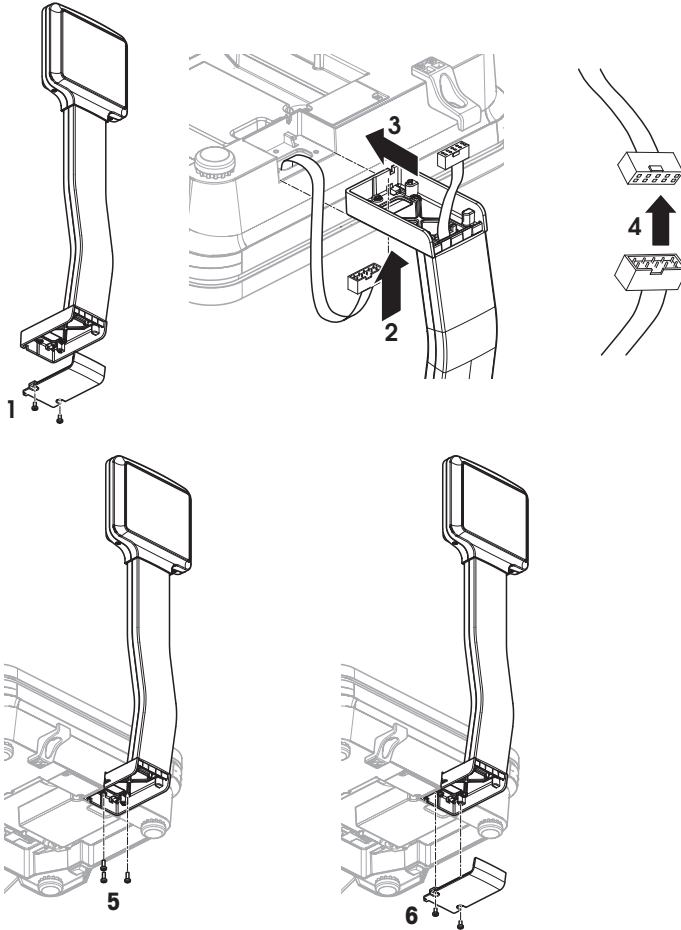

- Load plate removed and scale upside down.
- 1 Loosen the 2 screws at the bottom of the tower to remove the cover plate.
- 2 Route the cable from the scale through the opening at the bottom of the tower.
- 3 Put the tower on the scale and push it towards the scale as far as it will go.
- 4 Connect the cables from the scale and from the tower.
- 5 Mount the tower to the scale with 3 screws.
- 6 Fasten the cover plate with 2 screws at the bottom of the tower.
- 7 Turn the scale with the mounted tower into its normal position.

## 2.5 Hanging up the scale\*

\* Hanging up the scale is only required for bPlus-H2.

### Preparation

The load bearing structure is to be assessed by the manufacturer's/dealer's after sales service in collaboration with a qualified builder.



### Important Safety Message

The manufacturer/dealer, being unaware of local conditions, accepts no liability regarding the attachment of the hanging scale to its suspension or to a customized design.

The manufacturer's/dealer's service technicians are authorized to seek approval from a qualified builder.

### Safety precautions



### ⚠ WARNING

#### Risk of injury due to falling load

- In order to prevent accidents at work, the installer is required to take actions, directions and measures that comply with the general regulations for the prevention of industrial accidents, all other valid regulations for the prevention of accidents and with all other generally recognized regulations relating to safety and occupational medicine.

### Installation in natural stone or concrete, strength category C20/25

The load bearing structure must fulfill the following conditions:

Ceiling thickness	65 mm
Centre distance of raw/plugs $a_{\text{eff}}$	80 mm
Max. load per raw/plug in load direction	1 kN
Min. centre distance per raw/plug $a$	50 mm
Max. load per raw/plug in load direction	0.8 kN
Reduction factor $K_a$	$0.5 * (1 + a/a_{\text{eff}})$
Turning moment of anchoring device	25 Nm

### Maximum load of the bearing structure

Dead load	25 kg (scale and suspension)
Live load	15 kg max.

### Installation possibilities

- Mounting with suspension
- Mounting to your own suspension with round tubes
- Mounting to your own suspension with square tubes using the adapter



### Attaching the scale to the suspension

- 1 Mount the suspension to the ceiling.
- 2 Lay the power cable and interface cables (if present) from the ceiling through the suspension tube.
- 3 If needed, push the adapter over the square tube and fix it with 2 screws, washers and nuts.
- 4 Lay the power cable and interface cables (if present) through the tube inside the scale housing.
- 5 Push the scale's tube in the suspension tube or adapter and fix it with 4 screws.

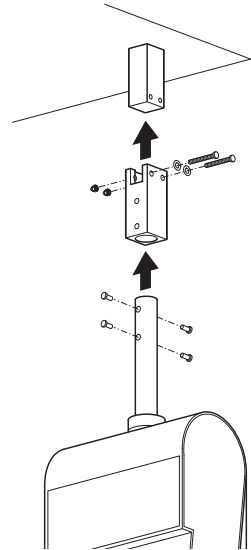
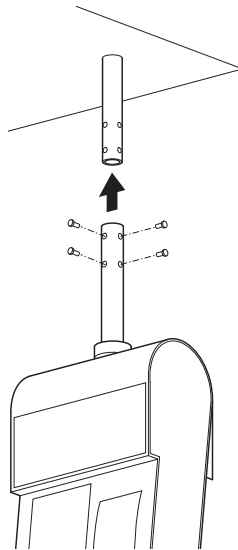

### Mains connection

- 1 Unscrew the sleeve and move the black rubber ring upwards.
- 2 Lift the sleeve off.
- 3 Lift off the roof of the scale.
- 4 Connect the power cable to the power connection socket.
- 5 Plug the power plug into a correctly grounded power outlet.

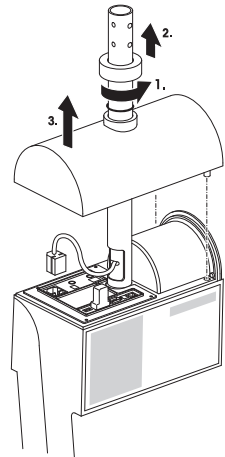

### Attaching the weighing arm

- Hang the weighing arm onto the scale.

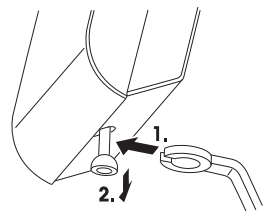



## 2.6 Inserting paper with bPlus-U2, bPlus-C2 and bPlus-T2

### 2.6.1 Paper format

Rolls must have the following dimensions:

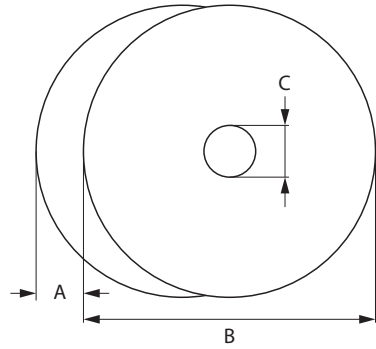
- A** max. 65 mm
- B** max. 120 mm
- C** min. 12 mm  
(40 mm with the spindle adapter)



-  The paper used (incl. liner paper) must not be thicker than 0.12 mm.
-  The paper weight should not be less than 48 g/m<sup>2</sup>, the paper weight recommended is 55 g/m<sup>2</sup>.

### 2.6.2 Opening the scale

- Open the cover of the scale.

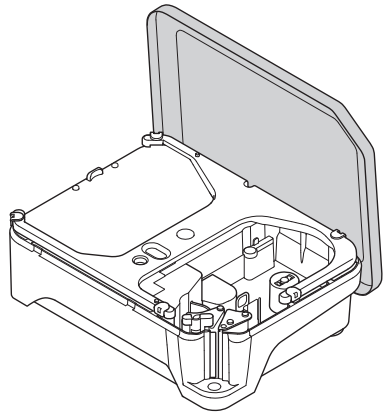

### 2.6.3 Inserting the ticket roll

#### Preparing the scale

- 1 If applicable: Remove the empty sleeve of the used roll.
- 2 Pull the spindle adapter from the spindle (1).
- 3 Push the spindle adapter into the storage position (2).
- 4 Push the ticket roll onto the spindle (3).

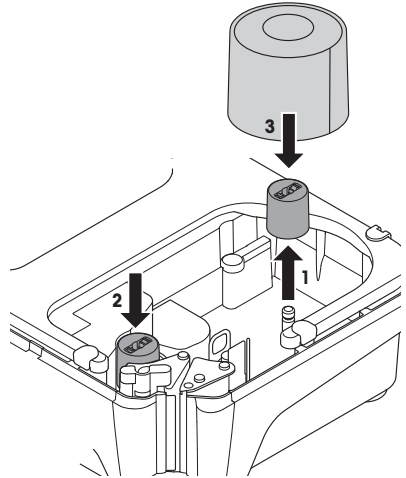

#### Inserting the ticket roll

- 1 Make sure that the colored handle (5) is in position "Open".
- 2 Guide the paper through the guide behind the paper removal mechanism as indicated in the diagram at the bottom of the scale.
- 3 Adjust the paper width using the small colored toothed wheel (4).
- 4 Close the colored handle (5).
- 5 Tear off the excess paper.
- 6 Close the cover of the scale.

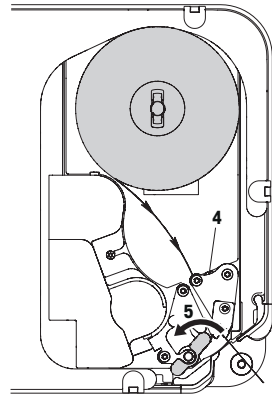

## 2.6.4 Inserting the label roll

### Preparing the scale

#### For label rolls with inner diameter $\geq 40$ mm

- 1 If applicable: Remove the empty sleeve of the used roll.
- 2 Pull the spindle adapter from the spindle (2).
- 3 Push the spindle adapter onto the spindle (2).
- 4 Push the label roll onto the spindle (3).

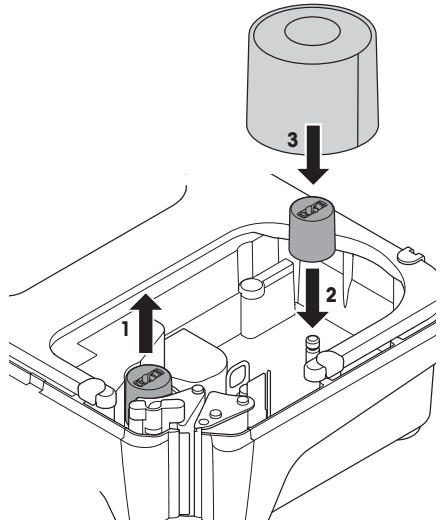

#### For label rolls with inner diameter $< 40$ mm

- 1 If applicable: Remove the empty sleeve of the used roll.
- 2 Pull the spindle adapter from the spindle (1).
- 3 Push the spindle adapter into the storage position (2).
- 4 Push the label roll onto the spindle.

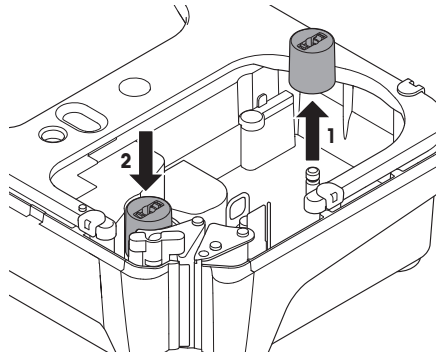

### Inserting the label roll

- 1 Make sure that the colored handle (5) is in position "Open".
- 2 Remove the labels from the first 20 cm of the liner paper.
- 3 Guide the liner paper through the guide behind the paper cutter as indicated at the bottom of the scale.
- 4 Wind the liner paper around the rewinder (4).
- 5 Close the colored handle (5).
- 6 Close the cover of the scale.

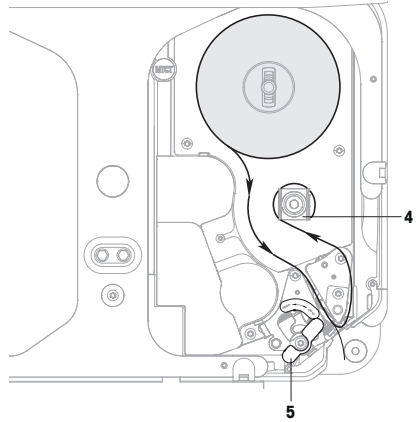

### 2.6.5 Inserting the linerless label roll

#### Preparing the scale

- 1 If applicable: Remove the empty sleeve of the used roll.
- 2 Pull the spindle adapter from the storage position (1).
- 3 Push the spindle adapter onto the spindle (2).
- 4 Push the label roll onto the spindle (3).

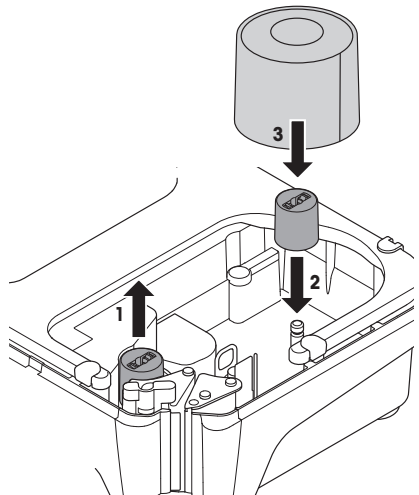

## Inserting the linerless label roll

- 1 Make sure that the colored handle (5) is in position "Open".
- 2 Guide the linerless labels through the guide behind the paper removal mechanism as indicated in the diagram at the bottom of the scale.
- 3 Adjust the paper width using the small colored toothed wheel (4).
- 4 Close the colored handle (5).
- 5 Tear off the excess label.
- 6 Close the cover of the scale.

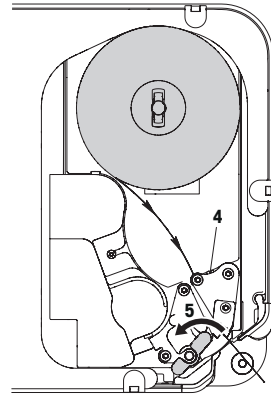

## 2.7 Inserting paper with bPlus-H2

### 2.7.1 Paper format

Rolls must have the following dimensions:

- A** max. 78 mm
- B** max. 122 mm
- C** min. 12 mm  
(40 mm with the spindle adapter)

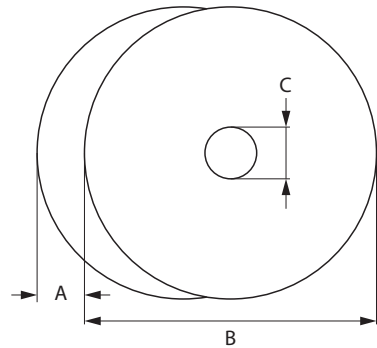

**i** The paper used (incl. liner paper) must not be thicker than 0.12 mm.  
Do not slam the printer door as this will damage the printer.

The paper weight should not be less than 48 g/m<sup>2</sup>, the paper weight recommended is 55 g/m<sup>2</sup>.

## 2.7.2 Opening the scale

- Open the printer door.

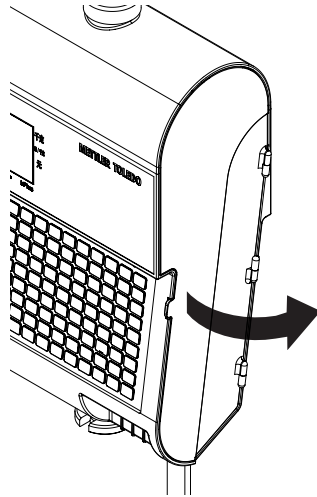

- Pull out the printer from the housing.

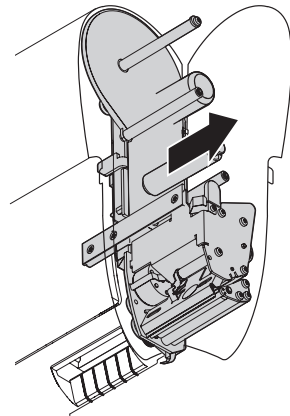

### 2.7.3 Inserting the ticket roll

- 1 Push the ticket roll onto the spindle.
- 2 Guide the paper through the guide behind the paper cutter as indicated at the bottom of the scale.
- 3 Push the printer into the housing.
- 4 Close the printer door.

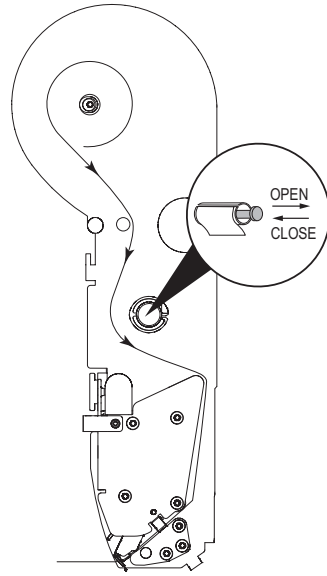

### 2.7.4 Inserting the label roll

- 1 Push the label roll onto the spindle.
- 2 Remove the labels from the first 20 cm of the liner paper.
- 3 Guide the liner paper through the guide behind the paper cutter as indicated at the bottom of the scale.
- 4 Wind the liner paper around the rewriter (1).
- 5 Push the printer into the housing.
- 6 Close the printer door.

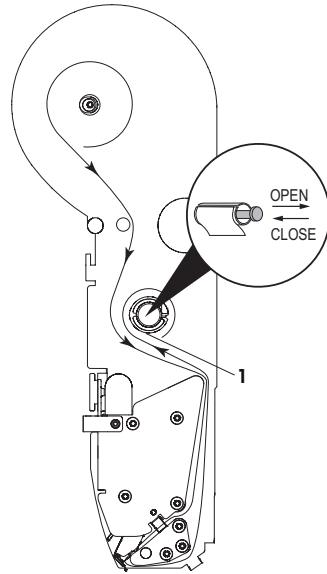



## 2.8 Connecting to mains power



### DANGER

#### Electrical shock hazard

- 1 Only connect the device to a properly grounded outlet.
  - 2 Only use the power cord supplied with the device.
  - 3 Use power outlets which are easily accessible and located no further than the length of the power cord.
  - 4 Do not remove the ground plug.
- 
- 1 Connect the supplied power cable to the power connection socket at the bottom of the scale.
  - 2 Plug the power plug into a correctly grounded power outlet.



## 2.9 Turning on

- Turn the scale on using the switch at the left bottom of the scale.
  - ⇒ After it is turned on, the scale is running through a short display test. All segments and status messages briefly light up.
  - ⇒ The GEO value and the software version are displayed.
  - ⇒ The scale is ready when the weight display appears.
-  The display may turn off automatically after 1 minute if this is configured in the energy saving settings.

## 2.10 Restart / Shutdown

### Shutdown

- Shut down the scale using the switch at the bottom of the scale.

**Note:** if a backup is required, the scale may need more time to shut down.

### Restarting/Hibernate

- 1 Press and hold the switch at the bottom of the scale.
  - ⇒ The following options show up:
    - 1 Restart
    - 2 Hibernate
    - 3 Shutdown
- 2 Use the arrow keys to choose the option and confirm with OK.

## 2.11 Setting up the network

- Your scale offers wired networks.
- I The maximum number of scales is limited to 99.

- 1 Connect the scale to the network hub via a cable.
- 2 Set IP mode to "Automatic" in sub-menu 251.

### 2.11.1 Network identification icon

In menu 259 "Network Icon Behavior", there are 4 options:

1 Identify Device	Shows how many devices of the same type this scale can identify in the same network. Identify device is through the same UDP port in menu 251. <ul style="list-style-type: none"><li>• If the scale identifies another bPlus, one black block will be displayed.</li><li>• If the scale identifies another two bPlus, two black blocks will be displayed.</li><li>• If 3 or more than 3 bPlus are identified, all the 3 black blocks will be displayed.</li></ul>
2 Data Server	Shows the status whether this scale is connected to the Data Server or not. "Retrieve data from server" will trigger the detecting.. <ul style="list-style-type: none"><li>• If "Retrieve data from server" is successful, all the 3 black blocks will be displayed.</li><li>• If "Retrieve data from server" failed, the blocks will be followed.</li></ul>
3. Transaction Log Server	Shows the status whether this scale is connected to the transaction Log Server or not. Make a transaction and the transaction log server will trigger the detecting. <ul style="list-style-type: none"><li>• If "Transaction log to server" is successful, all the 3 black blocks will be displayed.</li><li>• If "Transaction log to server" failed, the blocks will be followed.</li></ul>
4. SARP Server	Shows the status whether this scale is connected to a SARP Server or not. SARP Server is used for WAN (Wide Area Network) connection of Data Server or Transaction Log Server.

### 2.11.2 Wireless network (option)

#### Configuring the bPlus module

For a scale network in Wifi, it is required to have one (and only one) access point and the scales configured as client to connect to the access point. It is recommended for a good Wifi signal quality to have the central access point designed by a Wifi professional supplier.

When a central access point can not be installed, one of the scales can be defined as a Soft Access Point. It is very important to locate the Access Point in a network so that all scales can reach it easily. For more information, please refer to the Wifi documentation available. In case one scale is used as Soft Access Point, it should be located in the center of the network to have a good signal. The maximum number of scale networks is 6 when one scale is used as an access point: 1 Scale Access point + 5 Scales client. We recommend to setup the network with a scale Soft Access Point with a maximum distance of 15 m between the access point and the most distant scale. For more information, please refer to the Wifi documentation available.

#### Configuring a client scale

- This is to be done when an access point exists, and the scale needs to join the Network SSID.
- 1 Go to menu 252.
  - 2 Make sure the "Wifi module status" is set to "On".
    - ⇒ If not, select the first line and press OK to change the status to "On". Pressing OK again will move back to "Off".
  - 3 Make sure the "Wifi connection type" is set to "Client".
    - ⇒ If not, select the second line, press OK to open the menu, select Client (1) and press OK to validate.
  - 4 Select the 4th Line "Join Network" and press OK to display a list of available Wifi networks (list of SSID available including the channel used, sorted by SSID signal strength).
  - 5 Select with the arrows the desired network and press OK.
    - ⇒ A pop-up box shows up.

- 6 Enter the security password of the selected Wifi network.
- 7 Press OK or the Confirm soft key.
  - ⇒ The network connection will be established.
  - ⇒ On the top of the screen the message "Processing..." appears until the connection is established.
- 8 The client scale is now connected to the selected access point SSID.
- 9 Press the Back key to come back to the main menu
  - or –
  - Press the Menu key twice to come back to the main screen.

### Configure a soft access point scale

- This is to be done when no access point is available, and a scale has to be defined as the access point.
  - Please note, that in this case a maximum of 5 devices can connect to the soft access point scale.
- 1 Go to menu 252.
  - 2 Make sure the "Wifi module status" is set to "On".
    - ⇒ If not, select the first line and press OK to change the status to "On". Pressing OK again will move back to "Off".
  - 3 Make sure the "Wifi connection type" is set to "Access point".
    - ⇒ If not, select the second line, press OK to open the menu, select Access point (2) and press OK to validate.
  - 4 Select the 5th Line "Configure Network" and press OK..
    - ⇒ The configuration of the network screen appears.
  - 5 Define an SSID name by pressing OK and entering a name which will be displayed as SSID name in the Wifi network list and validate with OK. .
    - ⇒ A default SSID name is available - it is highly recommended to change it.
  - 6 Define a security level - press OK, select within the list (recommended is WPA2), validate with OK.
  - 7 Define a password - press OK, enter a password combination (at least 8 characters), validate with OK.
    - ⇒ A default password is available - it is highly recommended to change it.
  - 8 Set the access point mode: Press OK, select the desired mode, validate with OK.
    - ⇒ It is highly recommended to use "Auto (Mixed)" as the module will adapt itself to the Wifi condition environment. This should be done only by a knowledgeable technician, and after a Wifi Spectrum Analysis to check the signal status in either 2.4 GHz or 5 GHz.
    - ⇒ The access point scale is now able to receive client scales connections.
  - 9 Press the Back key to come back to the main menu
    - or –
    - Press the Menu key twice to come back to main screen.

## 2.12 Cleaning



### ⚠ CAUTION

#### Damage to the device

- 1 Turn off and unplug the device before cleaning.
  - 2 Do not open the device.
  - 3 Make sure that no fluids get inside the device.
  - 4 Do not use scouring powders or plastic dissolving cleaning agents for cleaning.
- 
- 1 Remove the weighing pan and clean it with a commercially available household detergent.
  - 2 If heavily soiled, clean the surface of the device with a damp cloth that has been dipped in water containing a mild washing-up liquid and has been wrung out well.

## 2.13 Disposal

In accordance with the requirements of European Directive 2012/96/EC on Waste Electrical and Electronic Equipment (WEEE), this device may not be disposed of with domestic refuse. This also applies for countries outside the EU in accordance with their respective national regulations.



- Please dispose of this product in accordance with local regulations for the separate collection of waste electrical and electronic equipment.

Should you have any questions, please contact the corresponding authorities or the dealer from whom this device was purchased.

If this device is passed on (for example for further private or commercial/industrial use), this regulation is also to be passed on.

Many thanks for your contribution to the protection of the environment.

### 3 Fast and easy operation



All procedures below are identical for all bPlus-U2, bPlus-C2, bPlus-T2 and bPlus-H2. The images show the bPlus-C2 device.

The availability depends on the region.

#### 3.1 Log in / log out

##### For multiple vendors



To do so, the following settings must be made:

- Vendors defined in sub-menu 121.
- "Vendor mode" set to "Multi Vendor" in sub-menu 233.

##### To log in

- 1 Press the [Login/Logout] key.
- 2 Use the arrow keys to select the vendor and confirm with OK.

##### To log out

- Press and hold the assigned Vendor key.

##### For single vendors



To do so, the following settings must be made:

- Vendors defined in sub-menu 121.
- "Vendor mode" set to "Single Vendor" in sub-menu 233.
- "Vendor Key" set to "As V1 Key" in sub-menu 233.

##### To log in

- Press the [Login/Logout] key.

##### To log out

- Press and hold the assigned Vendor key.

## 3.2 Free input

### 3.2.1 Free input in sales mode

You can immediately use your scale for weighing and selling, without prior configuration. With the factory settings, the scale can total several entries.

- 1 If `Enter PLU number` is displayed, press the PLU key.  
⇒ `Direct Price` is displayed.
- 2 Place the item on the scale.
- 3 Enter the unit price (price/kg) using the number keys.
- 4 Confirm the entry with the Vendor key.
- 5 For more items, repeat steps 1 to 4.
- 6 Total items with the Star key.  
⇒ The ticket is printed.

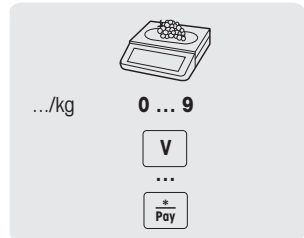

- When pressing the PLU key long, the default switches permanently from "Enter PLU number" to "Direct price".
- Enter the price as usual without the decimal point, but with all the decimal places.

### 3.2.2 Free input in pre-packing mode

You can immediately use your scale for weighing and selling, without prior configuration.

- 1 If `Enter PLU number` is displayed, press Switch key [#].  
⇒ `Direct Price` is displayed.
- 2 Place the item on the scale.
- 3 Enter the unit price (price/kg) using the number keys.
- 4 Confirm the entry with the Vendor key.  
⇒ The label is printed.
- 5 Take off the label.

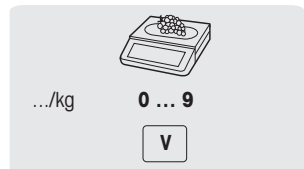

- Enter the price as usual without the decimal point, but with all the decimal places.

### 3.3 Working with PLUs

You can save your item data in the scale's PLU memory and easily call it up later.  
PLUs are created in sub-menu 111.

#### 3.3.1 Calling up a PLU

- 1 If **Direct Price** is displayed, press the Switch key [#].  
⇒ **Enter PLU** number is displayed.
- 2 Place the item on the scale.
- 3 Enter the corresponding PLU number.  
⇒ The unit price and item name appear in the display.
- 4 Confirm the entry with the Vendor key.  
⇒ The label is printed.
- 5 Take off the label.

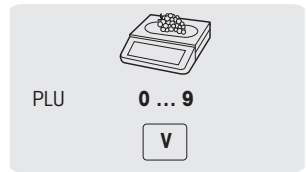

**I** If you discover that you have entered the wrong PLU number before you have confirmed the entry with the Vendor key, you can clear it with the Clear key and then enter the correct PLU.

#### 3.3.2 Calling up a PLU with preset keys

- You can save the most important PLUs to the keys in the keyboard.
- There are two layers of preset keys.

##### Preset keys on the first layer

- 1 Place the item on the scale.
- 2 Press the relevant preset key, e.g. "Grapes".  
⇒ The unit price and item name appear in the display.
- 3 Confirm the entry with the Vendor key.  
⇒ The label is printed.
- 4 Take off the label.

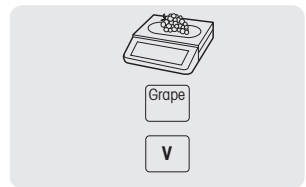

##### Preset keys on the second layer

- 1 Place the item on the scale.
- 2 Double press the relevant preset key.  
⇒ The unit price and item name appear in the display.
- 3 Confirm the entry with the Vendor key.  
⇒ The label is printed.
- 4 Take off the label.

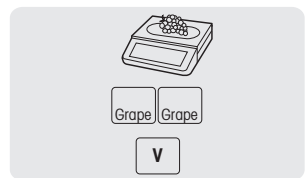

### 3.4 Using quantity PLUs and multiplication

With the multiplication function, you can enter several items for a PLU.

- 1 If `Direct Price` is displayed, press the Switch key [#].  
⇒ Enter `PLU` number is displayed.
- 2 Enter the `PLU` number of the item.  
⇒ The unit price and the item name appear in the display.
- 3 Press the X key to call up the multiplication function.
- 4 Enter the number of items.
- 5 Confirm the entry with the Vendor key.  
⇒ The label is printed and the multiplication function ends.
- 6 Take off the label.

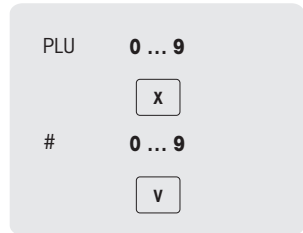

### 3.5 Taring

#### 3.5.1 Taring a container

**I** This function depends on the metrological limitation of the scale.

If you fill containers with your products or customers bring their own container, the tare function makes sure that only the contents are weighed and paid.

- 1 Place the empty container on the scale.
- 2 Press the Tare key.  
⇒ The scale is tared.  
⇒ The weight display is reset to 0.000 kg and the NET symbol appears.  
⇒ The tare weight is displayed in the bottom line of the display.
- 3 Fill the container with the goods to be weighed.
- 4 Call up the PLU by PLU number or directly enter the unit price.
- 5 Confirm the entry with the Vendor key.  
⇒ The label is printed.
- 6 Take off the label.

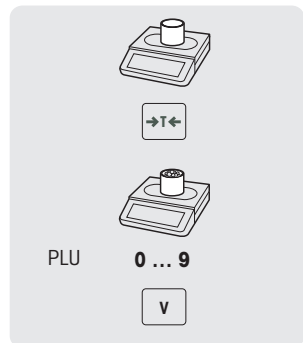



### 3.5.2 Manual tare

**i** This function depends on the metrological limitation of the scale.

If you know the weight of the container you can enter the tare weight via keyboard and weigh the full container.

- The scale is empty and the weight display is 0.
- 1 Press the Tare key.
- 2 Enter the tare weight via keyboard.
  - ⇒ The scale is tared.
  - ⇒ The weight display shows the negative tare weight.
  - ⇒ The tare weight is displayed in the bottom line of the display.
- 3 Place the full container on the scale.
  - ⇒ The net weight and the tare weight are displayed.
- 4 Call up the PLU by PLU number or directly enter the unit price.
- 5 Confirm the entry with the Vendor key.
  - ⇒ The label is printed.
- 6 Take off the label.

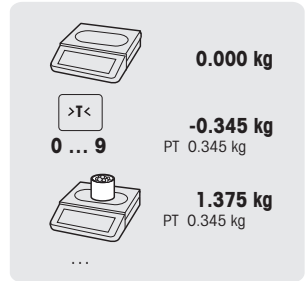

### 3.5.3 Customer tare / Basket function

**i** A maximum of 999 basket weights can be saved. If you have reached basket number 999, the scale automatically creates and prints a basket report. The basket number is then reset to 1.

Your customers pick fruit themselves, e.g., strawberries, and bring their own baskets. With the "Customer tare" function you can save the weight of each basket and recall it when weighing. This way, your customer only pays for what was actually picked.

**C** To do so, the following settings must be made:

- Keys defined as [Save Customer Tare] and [Recall Customer Tare] in sub-menu 232.

#### Saving customer tare weights

- 1 Place the customer's empty container on the scale.
- 2 Press the Tare key to tare the container.
- 3 Press the [Save Customer Tare] key.
  - ⇒ The tare weight is saved.
  - ⇒ A ticket with the number and weight of the container is printed.

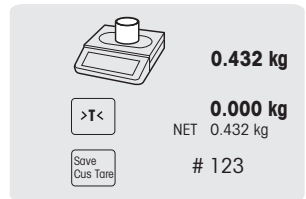

#### Recalling customer tare weights

- 1 Place the full container on the scale.
  - ⇒ The gross weight is displayed
- 2 Press the [Recall Customer Tare] key.
  - ⇒ A list with the customer tare tickets is displayed.
- 3 Select the customer tare ticket you want to proceed with.
  - ⇒ The net and tare weights are displayed.
- 4 Confirm with the Vendor key.
  - ⇒ The label is printed.
- 5 Take off the label.

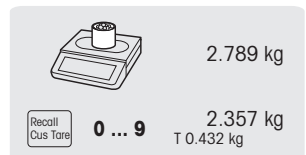

### 3.5.4 Multiple preset tare

**i** When selling, e.g., several boxes of the same PLU, the tare value of a single box needs to be multiplied.

**C** To do so, the following settings must be made:

- A key defined as [Multiple Tare] in sub-menu 232.

- 1 Place the full containers on the scale.
- 2 Call up a PLU with a preset tare.
- 3 Press the [Multiple Tare] key.
- 4 Enter the number of preset tares (e.g., 3 cans) and confirm with the OK key.  
⇒ The net and tare weights are displayed.
- 5 Complete the transaction as described in section Free Input.

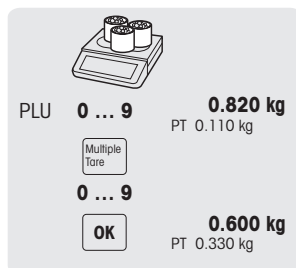

### 3.5.5 Default primary tare

**i** When you always use the same tare, e.g. a wrapping paper, you can work with default primary tare. In this case your scale will always operate with a fixed tare, e.g. 0.005 kg. As long as the default primary tare is used, you do not have to tare any more.

**C** To do so, the following setting must be made:

- Enter the primary tare value in sub-menu 213.

- With an empty scale, the weight display shows the negative tare value and the NET symbol is displayed.
- 1 Place the container or packaging material on the scale.  
⇒ The weight display should show 0.000 kg.
  - 2 Place the item on the scale.  
⇒ The net weight is displayed.
  - 3 Finish the transaction as described in section "Working with PLUs".

**i** To speed up weighing and selling you can combine steps 1 and 2 and place the full container or the item with wrapping paper on the scale.

## 3.6 Zeroing

**i** This function depends on the metrological limitation of the scale.

Due to soiling on the weighing pan or unfavourable external influences, it is possible that the weight display of an unloaded weighing pan may no longer be 0.000 kg. In such cases, the scale must be reset to zero.

- Press the Zero key.
- ⇒ The weight display is set to zero.

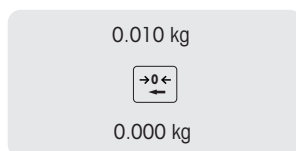

### 3.7 Large quantities

**i** Using the large sales function, you are able to book quantities higher than the scale capacity, e.g., a box of apples.

**C** To do so, the following settings must be made:

- "Large Sales" enabled in sub-menu 212.
- A key defined as [LS] key in sub-menu 232.
- If a vendor password is defined in sub-menu 121, you have to enter this password for entering large quantities.

- 1 Call up the PLU.  
⇒ The unit price and item name appear in the display.
- 2 Press the [LS] key.  
If required, enter your vendor password.  
⇒ The LS indicator lights up in the display.
- 3 Enter the known weight, e.g., 20 kg.
- 4 Confirm the weight with the Vendor key.  
⇒ The label is printed.
- 5 Take off the label.

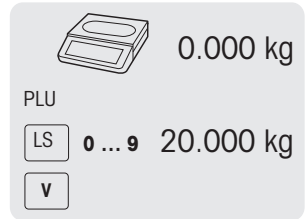

### 3.8 Weighing with 100 g price unit

**C** For many products, customers are used to a price per 100 g. If the PLU is defined with unit kg, the following settings must be made for weighing with 100 g price unit:

- "100g" enabled in sub-menu 215.
- A key defined as [100g] key in sub-menu 232.
- If a vendor password is defined in sub-menu 121, you have to enter this password for weighing with 100 g measuring unit.

- 1 Place the item on the scale.
- 2 Call up the PLU.  
⇒ The unit price (per kg) and item name appear in the display.
- 3 Press the [100g] key.  
If required, enter your vendor password.  
⇒ The 100g indicator and the unit price per 100 g are displayed for this item.
- 4 Confirm the weight with the Vendor key.  
⇒ The label is printed.
- 5 Take off the label.

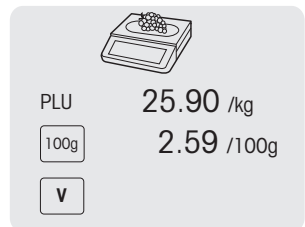

## 3.9 Working with several vendors

### 3.9.1 Working with several vendors on one scale (multiple vendor)\*

\* Function not available in all countries.

**C** For working with several vendors on one scale, the following settings must be made:

- Define up to 99 vendors in sub-menu 121.
  - Select "Vendor Mode = Multi Vendor" in sub-menu 233.
  - Either assign additional Vendor keys in 232 or select "V key = V + Vendor ID" in sub-menu 233.
- When working with several vendors on one scale, always use your individual Vendor key to enter items.
- To see the open transactions for each vendor which are not booked yet, the following settings must be made:
    - 1 Press the corresponding Vendor key to recall it.
    - 2 Press Vendor key twice to see the details of the PLU list which is booked by pressing the arrow up/down keys
    - 3 Press Back key to book another item.

### 3.9.2 Working with one vendor on one scale (single vendor key)

**C** For working with one vendor on one scale, the following setting must be made:

- Select "Vendor Mode = Single vendor" in sub-menu 233.
- When working on the scale, always use the Vendor key to enter items.

### 3.9.3 Working with several scales (floating vendor)

The availability depends on the region.

**C** With floating vendors, each vendor can work with any scale in a network of scales. To do so, the following settings must be made:

- Define up to 99 vendors in sub-menu 121.
- Select "Vendor Mode = Floating Vendor" in sub-menu 233.
- Either assign additional Vendor keys in 232 or select "V key = V + Vendor ID" in sub-menu 233.

#### Floating vendor

- The scale allows to have different Vendor keys for different vendors. Each active vendor has to be assigned to a particular Vendor key. Prior to using a vendor, the user needs to log in on the scale, in order for the assignment to become active
- In a network for several bPlus connecting with same AP, go to menu 233, configure "Vendor Mode" as: floating vendor. This configuration should be done in every bPlus in this network.
- Floating vendor will allow vendor to book transactions in different scales and print out the total label or ticket with all the transactions in one of the scales finally.

#### Example

Vendor 2 enters item 1 on scale A, item 2 on scale B and completes the transaction on scale C.

- 1 Place the item on any scale in the network, e.g., scale A.
- 2 Call up the PLU by PLU number or directly enter the unit price.
- 3 Confirm the entry with the Vendor key V2.
- 4 For more items, repeat steps 2 to 3 with any scale in the network, e.g., scale B.
- 5 Complete the transaction on any scale in the network as described in section Free Input.

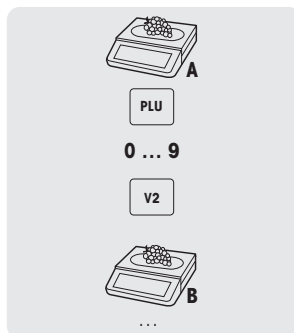

#### Working with floating vendor groups

- i**
- In case you have to support independent groups, e.g. open markets, you can use floating vendor groups.
  - It is possible to have the same vendor ID in 2 different groups, as well as the same vendor key in 2 different groups. I.e. vendor key 1 in vendor group 1 does not mean the same vendor as vendor key 1 in vendor group 2.
  - The vendor group is based on the scale and not on the vendor level.

**C** For working with floating vendor groups, the following settings must be made:

- Define vendor group sub-menu 233..

## 3.10 Printing options

### 3.10.1 Setup printing (ticket, label, linerless, endless)

The scale can print tickets as well as labels.

#### Types of printout

In sub-menu 242 the following types of printout can be selected:

- Ticket
- Label
- Linerless label (not for bPlus-H2)
- Total label
- Label + Total Label

#### Types of paper

In sub-menu 247 the following types of paper can be selected:

- Thermo paper
- Label (with line and die-cut)
- Endless label (with liner, without die-cut)
- Linerless label (without liner, without die-cut, availability depends on the country)
- Linerless black bar label (without liner, with black bars, for Chinese version only)



Before printing make sure that both "Printout type" and "Paper type" are set.

### 3.10.2 Printing a copy of the ticket

There are two ways to print a copy of the ticket: automatically and on demand.

#### Automatically printing a copy of the ticket

**C** For automatically printing a copy of the ticket, the following settings must be made:

- "Copy Tickets" set to "Auto print" in sub-menu 245.

#### Printing a copy of the ticket on demand

**C** For printing a copy of the ticket on demand, the following settings must be made:

- "Copy Tickets" set to "On Demand" in sub-menu 245.
- A key defined as [Ticket Copy on Demand] in sub-menu 232.

- 1 Book the items as described before.
- 2 Complete the transaction as described in section Free Input.  
⇒ The ticket is printed.
- 3 If a copy of the ticket is desired, press the [Ticket Copy on Demand] key.  
⇒ The copy of the ticket is printed.

### 3.10.3 Total label / Basket total label

#### Total label

**C** Total label is used to display the total price as well as a list of items (that have been packed together). To do so, the following settings must be made:

- "Total label" or "Label + Total label" activated in sub-menu 242.
- In sub-menu 243 the following settings have to be made:
  - Set "Upper Limit Total Label" to the maximum number of items you want on the total label.
  - Assign label IDs to "Subtotal 1" (total label) and "Subtotal 2" (PLU list).
- In sub-menu 247 "Paper Type" select a label.

- 1 Place an item on the scale and enter the PLU number.
- 2 Confirm with the Vendor key.
- 3 Repeat steps 1 and 2 for further items.
- 4 Total the items with the Vendor key.
  - ⇒ The (first) label is printed.
- 5 Make sure to take off the (first) label.
  - ⇒ If "Label + Total Label" is selected, the second label is printed.
- 6 Take off the second label.

**Note:** If "Label + Total Label" is selected in sub-menu 242, a separate label format which has been linked to each PLU will be printed out in addition.

#### Basket total label

**C** The basket total label provides a name on the total label. To do so, the following settings must be made:

- "Total label" or "Label + Total label" activated in sub-menu 242.
- In sub-menu 243 the following settings have to be made:
  - Combination PLU = Yes
  - Set "Upper Limit Total Label" to the maximum number of items you want on the total label
  - Assign label IDs to "Subtotal 1" (total label) and "Subtotal 2" (PLU list)
- In sub-menu 111 create a combination PLU (just fill in Item Number and Article Name (basket name)).
- In sub-menu 247 "Paper Type" select a label.

- 1 Place an item on the scale and enter the PLU number.
- 2 Confirm with the Vendor key.
- 3 Repeat steps 1 and 2 for further items.
- 4 Total the items with the Vendor key.
  - ⇒ "Total PLU No." is displayed.
- 5 Enter the combination PLU number and confirm with OK
  - ⇒ The (first) label is printed.
- 6 Make sure to take off the (first) label.
  - ⇒ If "Label + Total Label" is selected, the second label is printed.
- 7 Take off the second label.

**Note:** If "Label + Total Label" is selected in sub-menu 242, a separate label format which has been linked to each PLU will be printed out in addition.

### 3.10.4 Printing total labels using the total label key

**C** The  $\Sigma$  key is used to setup printing a total label in operating mode. Total labels are available on 2 levels.

To do so, the following settings must be made:

- In sub-menu 41 set "Mode" to "Pre-pack"..
- In sub-menu 432 "Total Label" or "Label 'Total Label'" is activated.
- In sub-menu 243 set "Subtotal 1" and "Subtotal 2".
- In submenu 247 select the desired paper type.

- 1 Press the  $\Sigma$  key.
- 2 Choose from the following:
  - ⇒ "No Preset Totals":  
No total labels are activated. Select this menu to de-activate the function.
  - ⇒ "Manual Total":  
The total label function is now activated.  
Pressing the Star key will sum up all transactions booked since the last total (or since choosing "Manual Total").  
Pressing the Star key twice will print the second level total label.
  - ⇒ "Semi-auto Totals":  
A new menu will open, see below.
  - ⇒ "Automatic Totals":  
A new menu will open, see below.

#### "Semi-auto Totals" and "Automatic Totals" menu

- 1 Select if the target total is to be done "by piece" or "by weight".
- 2 Enter target value for total level 1 either in kg or in pieces, depending on the previous selection.
- 3 Confirm the entry with OK.
- 4 Enter target value for total level 2 either in kg or in pieces, depending on the previous selection.
- 5 Confirm the entry with OK.
  - ⇒ The total label function is now activated.

#### Operation sequence with semi-auto totals

- 1 Book your transactions.
- 2 Once total level 1 is reached, a message will pop up asking if the total label should be printed or not.
  - ⇒ If "Yes" is selected (using the star key), the total label is printed.  
The sum is set to zero and the main screen is displayed.
  - ⇒ If "No" is selected (using the C key), no total label is printed.  
The sum is set to zero and the main screen is displayed.
- 3 Continue working and booking.
- 4 Once total level 2 is reached, proceed as described in step 2.

#### Operation sequence with automatic totals

- 1 Book your transactions.
- 2 Once total level 1 is reached, the total label is printed.
  - ⇒ The sum is set to zero and the main screen is displayed.
- 3 Continue working and booking until the next level is reached.



### 3.10.5 Batch printing

**C** You can comfortably printout labels for a whole batch of identical items. To do so, the following settings must be made:

- "Label" activated in sub-menu 24.
  - In sub-menu 232, a function key is defined as "[Multiple Label] key.
- Batch printing is not available for total labels.

- 1 Place the item on the scale and call up the PLU.  
– or –  
Call up the PLU of a piece article and enter the number of items.  
⇒ The total price is displayed.
- 2 Press the [Multiple Label] function key.  
⇒ A window opens to enter the number of labels.
- 3 Enter the number of labels and confirm with OK.  
⇒ The screen changes to the weight display.
- 4 Press the Print key  
⇒ The entered number of labels is printed.

### 3.11 Voiding

**i** Your customer decides not to buy one or more items which have already been weighed, but not paid. In this case, you can void unwanted items.

**C** To do so, the following setting must be made:

- "Void" must be enabled in sub-menu 212.

- 1 Press the Vendor key.  
⇒ The mini sales slip / total is displayed.
- 2 Press the Vendor key.  
⇒ The sales slip is displayed and can be edited.
- 3 Select the item which shall be voided.
- 4 Press the Void key to delete the selected item.
- 5 For more items, repeat steps 2 and 3.
- 6 Complete the transaction as described in section Free input.

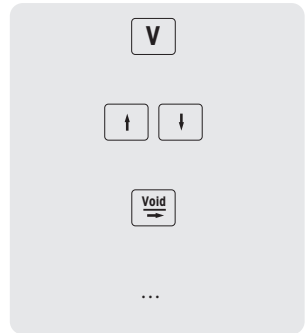

**i** Double press the Void key to delete all items.

### 3.12 Refunding

**i** Your customer has paid for an item, but would like to return it.

**C** To partially or completely refund the sales price, the following settings must be made:

- Refund enabled in sub-menu 212.
- A key defined as [Refund] in sub-menu 232.

- 1 Call up the PLU.  
⇒ The unit price and item name appear in the display.
- 2 Press the [Refund] key.  
If required, enter password.
- 3 Place the item to be refunded on the scale or enter the quantity and confirm with the Vendor key.  
⇒ The price to be refunded is displayed with negative sign.
- 4 For more items, repeat steps 1 to 3.
- 5 Complete the transaction as described in section Free input.

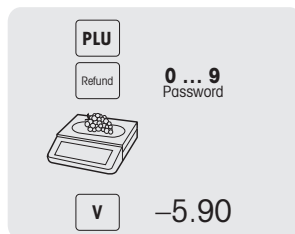

### 3.13 Suspending

**i** You have weighed and entered the items the customer wanted. But the customer is not able to pay immediately. In this case, you can suspend the already entered transactions and serve other customers in the meantime.

**C** To suspend a transaction, the following settings must be made:

- "Suspend" enabled in sub-menu 212.
- Keys defined as [Suspend] in sub-menu 232.

#### Suspending a transaction (ticket parking)

- 1 Book the customer's items and confirm each item with your Vendor key, but do not total the items.  
⇒ The ticket is suspended and you can serve another customer.
- 2 Press the [Suspend] key.

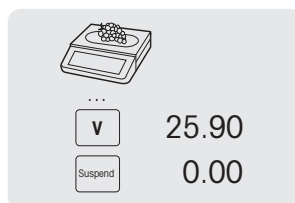

#### Recalling a suspended ticket

**i** To recall a suspended ticket, the following condition must be fulfilled:

- The vendor who recalls the suspended ticket has no open ticket.

**C** The following settings must be made:

- A key defined as [Recall Suspend] in sub-menu 232.

- 1 Press the [Recall Suspend] key.  
⇒ A list with the suspended tickets is displayed.
- 2 Select the ticket you want to proceed with.
- 3 Make the required changes.
- 4 Complete the transaction as described in section Free Input.

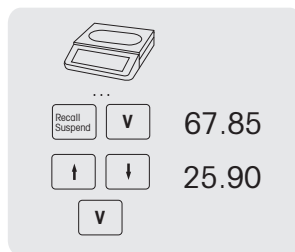

### 3.14 Reopening a ticket

**i** You have finished the transaction with the Star key and the ticket was printed. To reopen a ticket, the vendor who recalls the ticket cannot have an open ticket.

**C** To reopen the ticket, the following settings must be made:

- "Reopen ticket" enabled in sub-menu 218.
- A key defined as [Ticket Reopen] in sub-menu 232.

- 1 Press the [Ticket Reopen] key.  
⇒ Ticket No. is displayed.
- 2 Enter the number of the ticket you want to reopen and confirm with the Vendor key.
- 3 Make the required changes.
- 4 Complete the transaction as described in section Free Input.

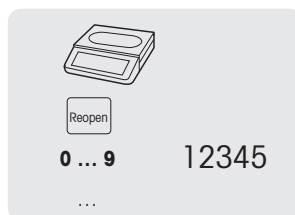

- i**
- When a ticket is reopened, a new ticket number is assigned to it.
  - On the printout of the reopened ticket both the old and new ticket numbers are printed.

### 3.15 Changing prices

#### 3.15.1 Overwriting a price temporarily

**C** To be able to change a PLU price, the following settings must be made:

- "Overwrite Price" enabled or set to "Up to PLU" in sub-menu 215.
- If the price overwrite is set to "Up to PLU", the functionality must be enabled for each PLU individually in sub-menu 111.
- A key defined as [Overwrite Price] in sub-menu 232.

- 1 Call up the PLU.
- 2 Press the [Overwrite Price] key and enter the new unit price directly.
- 3 Confirm with the Vendor key.  
⇒ The label is printed.
- 4 Take off the label.

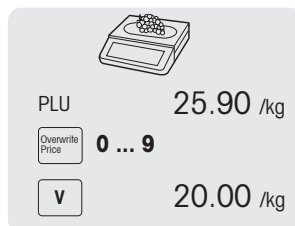

### 3.15.2 Overwriting a price permanently

- C** To be able to change a PLU price permanently, the following settings must be made:
- "Overwrite Price" enabled or set to "Up to PLU" in sub-menu 215.
  - If the price overwrite is "Up to PLU", the functionality must be enabled for each PLU individually in sub-menu 111.
  - Keys defined as [Save Price] and [Overwrite Price] in sub-menu 232.

- 1 Call up the PLU.
- 2 Press the [Overwrite Price] key and enter the new unit price directly.
- 3 Press the [Save Price] key.  
⇒ The new price is now saved permanently.
- 4 Confirm with the Vendor key.  
⇒ The label is printed.
- 5 Take off the label.

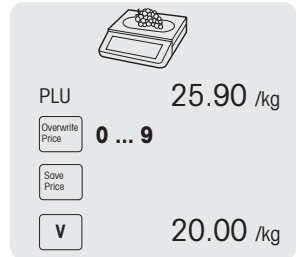

### 3.15.3 Changing to another price

- i** The scale offers the possibility to assign up to 5 prices to a PLU. The number of prices can be set in sub-menu 231.

If a vendor password is defined in sub-menu 121, you have to enter this password for changing prices.

- C** To be able to assign several prices to a PLU and switch prices, the following settings must be made:
- A key defined as [Change to other Price] key in sub-menu 232.
  - "Change to other Price" enabled in sub-menu 215.
  - Different unit prices defined for the PLU in sub-menu 111.
  - Activating the list of prices is also possible by using the [Change to Other Price] function key.

- 1 Place the item on the scale.
- 2 Call up the PLU.  
⇒ The first unit price and item name appear in the display.
- 3 Press the [Change to other Price] key. If required, enter your vendor password.  
⇒ The second unit price is displayed.  
⇒ When there are more than 2 prices stored, use the Arrow up / Arrow down keys to switch to further unit prices.
- 4 Finish the transaction as described in section "Working with PLUs".

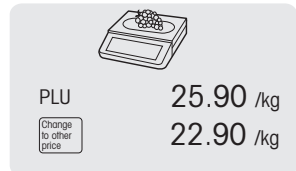

- i** To switch back to the first unit price, press the [Change to other Price] key again.

## 3.16 Granting discounts

### 3.16.1 Granting a discount on a single item

**C** To grant a discount, the following setting must be made:

- "Discount on Unit Price" or "Discount on Total Price" enabled in sub-menu F217.

**i** When choosing "Discount on Unit Price", the reduction is applied to price per weight/unit. When choosing "Discount on Total Price", the reduction is applied to the calculated item price.

Example:

- PLU 1: 10 EUR per kg
- Weighed good: 200 g
- Discount on total price: 10% on 2 EUR

- 1 Place the item on the scale.
- 2 Call up the PLU.  
⇒ The unit price and item name appear in the display.
- 3 Press the [Discount] key.
- 4 Enter the discount value.
- 5 Confirm the discount with the Vendor key.  
⇒ The reduced price is displayed.
- 6 For more items, repeat steps 1 to 5.
- 7 Complete the transaction as described in section Free Input.

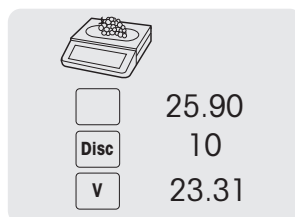

### 3.16.2 Granting a discount on the total sum

**C** To grant a discount, the following setting must be made:

- "Discount on Sales Total" enabled in sub-menu F217.

- 1 Book the customer's items and confirm each item with your Vendor key.
- 2 Total items with the Star key.
- 3 Press the Discount key.
- 4 Enter the discount value.
- 5 Confirm the discount with the Vendor key.  
⇒ The reduced total price is displayed.
- 6 Confirm with the Vendor key.  
⇒ The label is printed.
- 7 Take off the label.

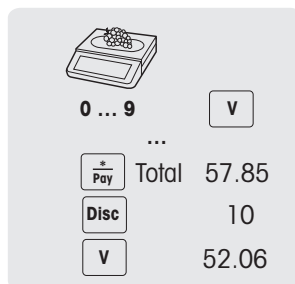

### 3.16.3 Granting a pre-defined discount

**C** To grant a pre-defined discount, the following settings must be made:

- Discounts defined in sub-menu F131.
- One of the following settings enabled in sub-menu F217.
  - "Discount on Unit Price"
  - "Discount on Total Price"
  - "Discount on Sales Total"

- 1 Place the item on the scale.
- 2 Call up the PLU.
  - ⇒ The unit price and item name appear in the display.
- 3 Press the [Discount List] key.
- 4 Select the desired discount value from the list.
- 5 Confirm the discount with the Vendor key.
  - ⇒ The reduced price is displayed.
- 6 For more items, repeat steps 1 to 5.
- 7 Complete the transaction as described in section Free Input.

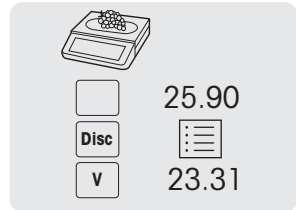

**I** To grant a pre-defined discount on the total sum, total items with the Star key and press the [Discount List] key.

## 3.17 Payment

### 3.17.1 Working with return

- 1 Book the customer's items and confirm each item with the Vendor key.
- 2 Total items with the Star key.
- 3 Press the Vendor key.
- 4 Enter amount given by the customer and confirm with the Vendor key.

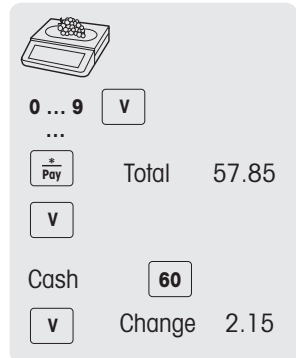

### 3.17.2 Working with multiple payment

**C** For multiple payment, e.g., with credit cards, cheques and vouchers, the following settings must be made:

- Payments defined in sub-menu F141.
- "Multiple Payment" enabled in sub-menu F218.

- 1 Book the customer's items and confirm each item with your Vendor key.
- 2 Total items with the Star key.
- 3 Press the Vendor key.
- 4 Select from the displayed payments.
- 5 Confirm the payment with the Vendor key.
- 6 Enter the amount and confirm with the Vendor key.
- 7 For multiple payment, repeat steps 3 to 6.
- 8 Complete the transaction as described in section Free Input.

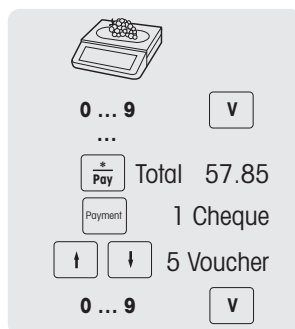

### 3.18 Cash in / cash out

**C** The scale offers the possibility to log cash in / cash out operations without a transaction. To do so, the following settings must be made:

- Keys defined as [Cash In] and/or [Cash Out] in sub-menu F232.

- 1 Press the [Cash In] or [Cash Out] key respectively.
- 2 Enter the amount of cash (e.g., 5000) and confirm with the OK key.  
⇒ The entered amount will show up in the cash report.

### 3.19 Working with VATs

#### 3.19.1 Assigning a group VAT

**i** The group VAT will only be applied when working with free price items or when the PLU VAT rate has not been defined.

**C** To be able to allocate a group VAT to a free price item or PLU, the following settings must be made:

- A VAT rate assigned to the group in sub-menu F113.
- The group assigned to a preset key.

- 1 If **Enter PLU number** is displayed, press the PLU key.  
⇒ **Direct Price** is displayed.
- 2 Place the item on the scale.
- 3 Enter the unit price (price/kg) with the number keys.
- 4 Press the [Group] key.  
⇒ The group is assigned and the respective VAT rate is used.
- 5 Confirm the entry with the Vendor key.
- 6 For more items, repeat steps 1 to 5.
- 7 Complete the transaction as described in section Free Input.

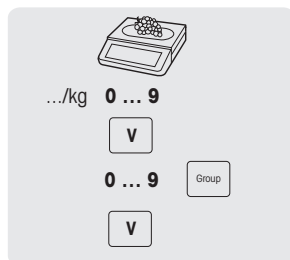

## 3.20 Traceability

### General

Traceability is a generic term used to describe a method to trace a product from its production to the final consumption, usually called "From Farm to Fork".

A product must be traceable at any stage of the production chain with a unique identification number. The unique identification number will be related to traceability information describing the "journey" of the product.

The unique identification number can be formed with different information depending on the country. It may sometimes be unique on a global level or only on a local level. In order to ensure correct traceability, the number has to be at least unique in the local level.

The traceability from the scale is only a small part of the complete traceability chain. However, it is often the last step, as the final consumer products will be labelled with this information.

### Terms

**Lot Number** Lot identifier, which is a unique identifier of a traceability object.  
Also defined as "Lot Number" in Arts model.

**Short Code** Index, batch identifier or date, consisting of an identifier for a Lot Number.  
The Short Code is assigned by the store to refer to a Lot Number.  
The Short Code must be unique in the group of traceability records.

**Payload** Text information related to the Lot Number.

#### Example of a typical payload information

Header	Value
Born in:	England
Raised in:	Scotland
Slaughtered in:	Italy
Cut in:	Switzerland
Race:	Angus
Type:	Beef
Date of Birth:	08.08.2010
Date of Slaughter:	12.12.2014
Date of Cut:	12.12.2014

**Traceability record** Consisting of

- Trace Info ID
- Lot Number
- Short Code
- Payload
- Lot Control Data (optional)

**Trace Info ID** A reference to a group of traceability records.

### Traceability possibilities on your scale

The lot can be linked to ...

- ... an item/PLU
- ... a group
- ... a department

For each of these configurations it can be mandatory or optional to use a lot while selecting the item/PLU. If the traceability is mandatory for the PLU/group/department, the PLU can only be selected with a valid lot.

### Identifying a traceability object / traceability record

There are two ways to identify a traceability object:

- by Lot Number
- by Trace Info ID + Shortcode



### Detailed information on the Trace Info ID

- For item/PLU traceability (configured in sub-menu 111):
  - A lot linked to an item/PLU means that this PLU will only be able to use/access this Trace Info ID (lot).
  - However, the same Trace Info ID (lot) can be linked to different PLUs.
- For group traceability (configured in sub-menu 113):
  - A lot linked to a group means that all items/PLUs of this group will be able to use/access this Trace Info ID (lot).
  - An item/PLU from another group will not be able to use/access this lot..
- For department traceability (configured in sub-menu 114):
  - A lot linked to a department means that all items/PLUs of this department will be able to use/access this Trace Info ID (lot).
  - An item/PLU from another department will not be able to use/access this lot.

### Creating/uploading traceability records to the scale

Traceability records will be uploaded "ready to use" from a PC Tool.

#### Setting up traceability in the scale

- 1 Go to menu 129.
- 2 Create New?: Press OK to create new traceability.
- 3 Trace Info ID: Press OK to input your trace index. For example input 1 here
- 4 Create Short Code: Press OK to input your short code. For example input 11 here..
- 5 Lot Number: Press OK to input your lot number.  
Press "00" key can change your input method. For example input "123456789".  
When finished, press OK to confirm.
- 6 Create Date: Press OK.  
Arrow left or right keys can move your cursor, pressing the "Clear" key can delete the numbers.
- 7 After these options are input, press the "Back" key to view your lot number.
- 8 Pressing the Back key and Arrow up/down keys, you can view the list of lot number.  
⇒ The scale will generate the short code for the same index lot number.

#### Selection and display of a traceability record

- When the Trace Info ID is defined, there are the following possibilities to select and display it:
  - If there is only one Trace Info ID (lot) linked to the selection (typical case: PLU traceability), only one lot information will pop up.  
If it is mandatory, then the PLU can only be used with this Trace Info ID.
  - If there are multiple Trace Info IDs (lots) available for the selection (typical case: group or department traceability), a list of available lot information will pop up.  
If it is mandatory for the group or department, then the PLU can only be used if a Trace Info ID is selected.
- When calling up a PLU, it is possible to recall the Trace info ID (lot number) with a Barcode scanner. In this case simply scan the barcode when the scale requests the Trace Info ID.
- It is possible to define how the Trace Info IDs will be sorted when popping up after a PLU was called up (refer to sub-menu 214):
  - Creation date
  - Short code number
  - Lot number
- It is also possible to select the Trace Info ID via its Short code number by simply entering the number.  
I Only valid traceability records will be displayed.



### 3.21 Backup / restoring data via USB device

#### Recommended USB sticks

It is important to know that a poor-quality USB stick could lead to data writing problems. To avoid any troubles, we strongly recommend you to buy a good quality and reliable USB stick.

In order to help you in your research, here is a suggestion of some well-known brands:

- SanDisk
- Kingston
- Lexar
- PNY
- Patriot

The storage device should also have a decent storage capacity to archive a large amount of data. A USB stick of 8 GB should be enough to store all your data.

**I** Because it is easy to lose or to damage a USB stick, the stick alone is not considered as a durable and reliable archive.

#### Backup data to a USB device / restoring data from a USB device

- 1 Plug the USB device into the USB connector at the bottom of the scale.
- 2 Use the Arrow up / Arrow down keys to select "Backup data to USB" respectively "Restore data from USB" and confirm with the OK key.
- 3 Use the Arrow up / Arrow down keys to move through the options:  
"Item data" – scale data  
"Configuration" – scale configuration, bitmap and label, if available  
"Keyboard" - scale keyboard  
"Transaction log" – transaction log file only  
"All data" – item data, configuration data and transaction log file
- 4 Select or deselect an option by using the OK key.
- 5 Start back up/restore with the Vendor key.  
⇒ The selected data are transmitted to or from the USB device.  
⇒ When the data transmission is finished, *Accomplished* will be displayed.
- 6 Unplug the USB device.

## 3.22 Temporary changes

### 3.22.1 Changing the date temporarily

**i** Different types of date are often required by regulations or interested by the end customers. Most commonly used dates such as "Pack Date", "Sell by Date" and "Use by Date" are ready for editing. In addition a customized date such as "Fishing Date" can be changed as well.

**C** To be able to change a date, the following settings must be made:

- The requested dates must be enabled in sub-menu 231. The dates for an item can be edited in sub-menu 111.
- Keys for temporarily changing the date [Change Pack Date], [Change Pack Date], [Change Sell By], [Change Use By], [Change Customized Date1], [Change Customized Date2] must be mapped to the preset keys in sub-menu 232.

- 1 Place an item on the scale and enter the PLU number.
- 2 Press the desired [Change ... Date] key.
- 3 If the format is set to "Days" in sub-menu 111, enter the new number of days.  
If the format is set to "Date" in sub-menu 111, enter the new date in the format DDMMYYYY.
- 4 Confirm the new date with OK.
- 5 Confirm the change with the Vendor key.  
⇒ The label is printed.
- 6 Take off the label.

### 3.22.2 Changing the label format temporarily

**i** The label format is used to design the content of the label. Customized label formats can be created or edited and transferred via PC tool to the scale.

**C** To be able to change a label format, the following settings must be made:

- The number of label formats must be set in sub-menu 231.
- A label format must be linked to a PLU in sub-menu 111.
- A key [Change Label No.] must be mapped to the preset keys in sub-menu 232.

- 1 Place an item on the scale and enter the PLU number.
- 2 Press the [Change Label No.] key.
- 3 Enter the new label number and confirms with OK.
- 4 Confirm the change with the Vendor key.  
⇒ The label is printed.
- 5 Take off the label.

### 3.22.3 Changing the extra text temporarily

**i** Extra text is used to display additional information about an item, e.g. ingredients, allergens, ...

**C** To be able to change a label format, the following settings must be made:

- Extra text can be created or edited in sub-menu 126.
- Extra text must be enabled in sub-menu 231.
- An extra text ID must be linked to a PLU in sub-menu 111.
- A key [Change ET No.] must be mapped to the preset keys in sub-menu 232.

- 1 Place an item on the scale and enter the PLU number.
- 2 Press the [Change ET No.] key.
- 3 Enter the new extra text number and confirm with OK.
- 4 Confirm the change with the Vendor key.  
⇒ The label is printed.
- 5 Take off the label.

### 3.22.4 Changing the department temporarily

**i** As for categories and groups, PLUs can be sorted into different departments. The combination of department ID and PLU number is unique, e.g. PLU 1 can be used in both, department 1 and 2.

#### First method

**C** To be able to change the department temporarily, keys [Change Department] and [Cross Selling] must be mapped to the preset keys in sub-menu 232.

- 1 Place an item on the scale and enter the PLU number.
- 2 Press the [Change Department.] key.
- 3 Enter the new department ID and confirms with OK.
- 4 Confirm the change with the [Cross Selling] key.  
⇒ The ticket/label is printed.
- 5 Take off the ticket/label.

#### Alternative method

**C** Alternatively a department can be mapped to the preset keys in sub-menu 114.

- 1 Press the [Department] key.
- 2 Place an item on the scale and enter the PLU number.
- 3 Confirm with the Vendor key.  
⇒ The ticket/label is printed.
- 4 Take off the ticket/label.

**i** To be able to change the department **permanently**, a key [Change Department] must be mapped to the preset keys in sub-menu 232.

## 4 Menu

### 4.1 Menu operation

#### 4.1.1 Entering the menu



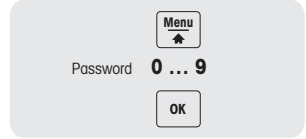

 Default password: 2666666

- 1 Press the Menu key.
- 2 Enter the password.
- 3 Confirm the entry with the OK key.



#### 4.1.2 Key functions in the menu

The following keys can be used in the menu:

Key	Name	Function
	Menu key	<ul style="list-style-type: none"><li>• Enter the menu</li><li>• Press and hold or double click to quickly return to the weighing mode</li></ul>
	Arrow up key	Go to previous item
	Arrow down key	Go to next item
	OK key	Confirm selection
	Back key	Go to previous level

#### 4.1.3 Navigating in the menu

- 1 Enter the menu.
- 2 Use the Arrow up / Arrow down keys to select a menu on the highest level, e.g., 1 Data.
- 3 Confirm the selection with the OK key.
- 4 Use the Arrow up / Arrow down keys to select a menu, e.g., 11 Item Data.
- 5 Confirm the selection with the OK key.
- 6 Use the Arrow up / Arrow down keys to select a sub-menu, e.g., 111 PLU Database/ Edit.

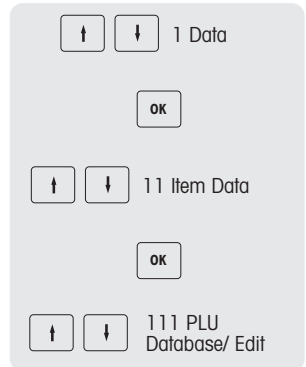

#### Direct access to the sub-menu

- 1 Enter the menu.
- 2 Enter menu or sub-menu number, e.g., 111.
- 3 Confirm the entry with the OK key.

#### 4.1.4 Ending the menu

- Press and hold the Menu key until the weight display appears again.
- ⇒ The scale is now in the normal operating mode.
- or -
- Press the Back key repeatedly until the normal operating mode is displayed.



#### 4.1.5 Text input

There are two ways to enter text: via the numeric keys and via the preset keys.

##### 4.1.5.1 Text input via numeric keys

Text input on the scale works like on a mobile phone.

Press the numeric key [00#] to toggle between numbers (123) and letters (ptw or PTW).

##### Example

Entering article name "Apple":

Key	Action	Display
<b>8</b>	Press once	A
<b>1</b>	Press once	Ap
<b>1</b>	Press once	App
<b>5</b>	Press three times	Appl
<b>9</b>	Press twice	Apple
<b>Abc</b>	Lower case letters, first letter uppercase	
<b>ABC</b>	Upper case letters	
<b>abc</b>	Lower case letters	
<b>Uni</b>	Unicode characters	
<b>Symbol</b>	Special symbols	

### 4.1.5.2 Text input via preset keys\*

\* For bPlus-T2, this function is not available.

When text input is requested, the assignment of the preset keys switches to a keyboard representing alphabetic characters.

Use the SHIFT key to switch between small and capital letters and special characters, if applicable.

#### bPlus-U2 / bPlus-C2

L/C	C1	C2	C3	C4	C5	C6	C7	C8	C9	
L1							A ÁÂÃÄÅÆ	B	ÇÇÇ	
L2							DÐ	EÉÊËËËËË	F	
L3							G	H	ÍÎÏ	
L4							J	K	LËË	
L5							M	NÑÑÑ	OÓÔÕÖØ	
L6	P	Q	RŘR	SŠ&S	TŦP	UÚÛÜÛ	V	W	X	
L7	YÝ	ZŽŽŽ								
L8	SHIFT	SPACE	.,:	{}[]	"' _\	%&@&\$	! ?¿	<>-*+=#	\$€#&©@&ç	

# bPlus-H2

L/C	C1	C2	C3	C4	C5	C6	C7	C8	C9	C10	C11
L1	A ÁÀÁÁÁÁÁ/Æ/À	B	ÇÇÇÇ	ÐÐÐ	ÉÉÉÉÉ/Ê/Ë	F	G	H	ÌÌÌÌ	J	K
L2	ĹĹĹ	M	ÑÑÑÑ	ÓÓÓÓÓ/Ô	P	Q	RŔŖ	ŠŠŠŠ	ŤŦ	ÚÚÚÚÚ	V
L3	W	X	ÝŸ	ẒẒẒ							
L4											
L5											
L6											
L7											
L8	SHIFT	SPACE	...:	Ö[]	“”_’	%&@&#					
L9	◀-+&#	SEVŠ@©	!/?¿								



## 4.2 Menu description

### 4.2.1 Overview

In the menu, you can set up the scale to handle your special sales and back office tasks. Specific functions and groups are only accessible if you have a license. Ask your sales representative for this.

The availability of certain menu items depends on the region.

The menu features are organized in the following menu tree:

Menu group	Menu	Sub-menus
1 Data	11 Item Data	111 PLU Database / Edit
		112 Category
		113 Group
		114 Department
		115 Preset Tare
		116 Barcode
		117 VAT
		118 PLU List Printout
		119 PLU Label Printout
		12 Data Warehouse
	122 Scale	
	123 Store	
	125 Customer	
	126 Description Text by Type	
	127 Description Text by ID	
	128 Running Message	
	129 Trace Info	
	13 Price Management	
	14 Payment	141 Payment Method
		142 Currency Library

Menu group	Menu	Sub-menus
2 Configuration	21 Operation Center	211 Item Recall
		212 Item Registration
		213 Tare
		214 Traceability
		215 Price
		217 Discount
		218 Payment
		219 Others
		23 General Settings
	232 Function Keys (Key Mapping)	
	233 Vendor	
	235 Licenses	
	236 Training	
	238 Change domain password	
	24 Printing	242 Printout Type
		243 Label Configuration
		245 Ticket Configuration
		246 Ticket Content
	25 Connectivity	251 Network
		252 Wireless
		256 Transaction Log Server
		257 Data Server
		259 Other
	27 Control Panel	271 Display
		272 Sound
		273 Power Management
		274 Date and Time
		275 Language
	28 System	281 Memory
		282 Reset
		283 Printout System Info

<b>Menu group</b>	<b>Menu</b>	<b>Sub-menus</b>
3 Reports	31 Single Reports	311 Sales Report
		312 PLU Report
		313 VAT Report
		314 Vendor Report
	33 Combination Report	331 Daily
		332 Period A
		333 Period B
		334 Period C
		335 Close Store
	34 Clear Period	341 Clear Period A
		342 Clear Period B
		343 Clear Period C
		244 Clear All Periods
	36 Z Report	361 Daily Closing
		363 Monthly Closing
		364 Yearly Closing
365 Auto Closing Configuration		
4 Mode	41 Mode Selection	
	42 Start Mode	
	43 Pre-packing Configuration	431 Auto Print
		432 Print Type
		433 Default Vendor
		434 Fix Default State
		435 Min Recall Key Counts PLU
436 Paper Type		
5 Advanced	51 Scanner	511 Port Configuration
		512 For Recall and Book

## 4.2.2 Data menu

In the **Data** menu you are able to enter the following data:

- Item Data (PLUs)
- Data Warehouse
- Price Management

No.	Display	Description	Possible values
<b>11 Item Data</b>			
<b>111</b>	<b>PLU Database</b>	<b>Edit PLUs</b> The available PLU items depend on the setting of 231 PLU Editing Fields.	Create New? Existing items
	Item Number	Enter the item (PLU) number	1 ... 99'999'999
	Article Number	Enter the article number	Max. 32 characters
	Article Name #	Enter up to 2 article names	Max. 64 characters each
	Unit Price #	Enter up to 5 unit prices	0.01 ... 9'999.99
	Unit of Measures	Select the unit of measures <ul style="list-style-type: none"> <li>• For weight articles, use units <b>kg</b> or <b>100g</b>.</li> <li>• For piece articles, use <b>PCS</b> only.</li> </ul>	1 kg 2 GRM 3 100g 4 PCS 5 Others
	Customized Unit	Configure your own unit of measures	Max. 32 characters
	Limit above to	Define until which weight / amount of units the first staggered price should be used	0.001 ... 999.999
	Unit Price Staggered	Define which price should be used until the first weight / unit limit is reached	0.01 ... 9'999.99
	Discount	Allow discount for this PLU	Enable/Disable
	Price Overwriting	Allow price overwrite for this PLU	On/Off
	Markup	Allow markup for this PLU	Enable/disable
	Category	Select the article category	1 None # Existing categories # New (refer to 112)
	Group	Select the article group	1 None # Existing groups # New (refer to 113)
	Preset Tare	Select a preset tare	1 None # Existing preset tare values # New (refer to 115)
	Barcode Number	Select a barcode number (for creating a new barcode refer to 116)	1 ... 99
	VAT	Select a VAT	1 None # Existing VATs # New (refer to 117)
	Extra Text	Enter an extra text	ID (of an existing extra text) Text (individual extra text for the selected PLU)
	Label Format 1	Select an existing label format which has been defined with the SmartLabel software	1 ... 99
Label Format 2			
Label Format 3			

No.	Display	Description	Possible values
111 con- tinued	Pack Date Print Flag	Switch the print flag for the date of packing on/off. If set to "On", "Pack Date Type" and "Pack in ..." are required.	On/Off
	Pack Date Type	Select the type of pack date. The following entry will depend on this selection.	1 Days 2 Date
	Pack in Days	Enter number of days	-99 ... 99
	Pack in Date	Enter the packing date in the displayed format	
	Use-By Print Flag	Switch the print flag for the use-by date on/off.	On/Off
	Use-By Date Type	If set to "On", a "Use-By Date Type" and "Use-By in ..." is required. Select the type of use-by date. The following entry will depend on this selection.	1 Days 2 Date 3 Hours 4 Time
	Use-By in Date	Enter day, month, year in the displayed format	
	Use-By in Days	Enter number of days	0 ... 999
	Use-By in Hours	Enter hours	0 ... 23
	Use-By in Time	Enter hours, minutes, seconds in the displayed format	
	Sell-By ...	Refer to "Use-By ..."	
	CustomizedDate1 ...	Refer to "Use-By ..."	-99 ... +99
	CustomizedDate2 ...		
	Fix Weight	Enter a fixed piece weight	1 ... 12.000 Unit [g]
	Image 1	Enter the name of an existing image which has been defined with the SmartLabel software	Max. 8 characters
	Image 2		
	Image 3		
Trace Info ID	Enter traceability info ID (Reference to a group of traceability records, refer to 214)	Max. 32 characters	
NutritionInformation ID	Enter nutrition info ID	1 None # Existing IDs # New (refer to 115)	
112	<b>Category</b>	<b>Define article categories</b>	Create New? Existing categories
	Category ID	Enter category ID	1 ... 99
	Category Name	Enter category name	Max. 32 characters

No.	Display	Description	Possible values
113	<b>Group</b>	<b>Define article groups</b>	Create New? Existing groups
	Group ID	Enter group ID	1 ... 99
	Group Name	Enter group name	Max. 32 characters
	Traceability Mandatory Flag	Enable/disable traceability mandatory flag for the article group	1 Enable 2 Disable
	Trace Info ID	Enter trace info ID	0 ...99999999
	VAT ID	Select a VAT	1 None # Existing VATs # New (refer to 117)
114	<b>Department</b>	<b>Define departments</b>	Create New? Existing departments
	Department ID	Enter department ID	1 ... 9999
	Department Name	Enter department name	Max. 32 characters
	Traceability Mandatory Flag	Enable/disable traceability mandatory flag for the article group	1 Enable 2 Disable
	Trace Info ID	Enter trace info ID	0 ...99999999
115	<b>Preset Tare</b>	<b>Define preset tares for frequently used tare weights</b>	Create New? Existing tare presets
	Tare ID	Enter preset tare ID	1 ... 99
	Tare Name	Enter preset tare name	Max. 32 characters
	Tare Value	Enter preset tare weight	Depending on the scale capacity
116	<b>Barcode</b>	<b>Define barcodes</b>	Create New? Existing Barcodes
	Barcode ID	Enter barcode number	1 ... 99
	Barcode Name	Enter barcode name	Max. 32 characters
	Barcode Type	Select barcode type	1 EAN8 2 EAN13 3 ITF25 4 Code128 5 UPC-A 6 QRCode
	Barcode Format	Define barcode format. The barcode of the example (EAN13) consists of the following items: <b>AAAAAA</b> : PLU number, 6 characters <b>BBBBBB</b> : Total price, 6 characters <b>C</b> : Barcode check digit, 1 character	Refer to [Setting up a barcode ▶ Page 87]
117	<b>VAT</b>	<b>Define VATs</b>	Create New? Existing VATs
	VAT ID	Enter VAT ID	1 ... 99
	VAT Name	Enter VAT name	Max. 20 characters
	VAT Inhouse	Enter VAT value for inhouse-consumption, e.g., in a restaurant	1 ... 100 (%)
	VAT Take-Away Food	Enter VAT value for take-away food	1 ... 100 (%)

No.	Display	Description	Possible values
<b>118</b>	<b>PLU List Printout</b>	<b>Print out a list of the PLUs entered</b>	
	Start PLU Number	Enter start PLU number	1 ... 99'999'999
	End PLU Number	Enter end PLU number	1 ... 99'999'999
<b>119</b>	<b>PLU Label Printout</b>	<b>Print out the assigned labels for the selected PLUs</b>	
	Start PLU Number	Enter start PLU number	1 ... 99'999'999
	End PLU Number	Enter end PLU number	1 ... 99'999'999

No.	Display	Description	Possible values
<b>12 Data Warehouse</b>			
<b>121</b>	<b>Vendor</b>	<b>Define vendors</b>	Create New? Existing vendors
	Vendor ID	Enter vendor ID	1 ... 99
	Vendor Name	Enter vendor name	Max. 32 characters
	Vendor Password	Enter vendor password	1 ... 9'999'999
	Vendor Map Key	Assign a Vendor key. For assigning more Vendor keys refer to 232.	1 None 2 V key 3 V2 key 4 V3 key 5 V4 key
<b>122</b>	<b>Scale</b>	<b>Enter scale data</b>	
	Scale ID	Enter your individual scale ID	1 ... 65'535
	Last IP is Scale No	Instead of an individual scale number the last segment of the IP address can be used as scale number	On/Off
	Scale Name	Enter scale name	Max. 64 characters
	Department	Select the department, to which the scale belongs	Departments have to be configured using a PC tool
<b>123</b>	<b>Store</b>	<b>Enter store data</b>	
	Store ID	Enter store ID	1 ... 99
	Store Name	Enter store name	Max. 32 characters
	Store Logo	Enter store logo	Max. 32 characters
	Store Safehandling	Enter store safe handling information, e.g. "Do not smoke"	Max. 32 characters

No.	Display	Description	Possible values
<b>125</b>	<b>Customer</b>	<b>Enter customer data</b>	
	Customer ID	Enter customer ID	1 ... 999
	Customer Name	Enter customer name	Max. 64 characters
	Phone number	Enter customer phone number	Max. 32 characters
	E-mail	Enter customer e-mail address	Max. 64 characters
	Address	Enter customer address	Max. 64 characters
	Credit Limit	Enter customer credit limit	0 ... 999'999'999
	VAT	Enter customer VAT rage	Max. 64 characters
	Discount	Enter customer discount rate	0 ... 100 %
	Amount of printouts	Enter number of printouts for the customer's orders	1 ... 99
	Signature	Signature on the printout	Enable/disable
	State	Define the customer state. The customer state only can be set as disabled when there is no open account.	Enable/disable
<b>126</b>	<b>Description by text type</b>	<b>Enter texts, organized by text type</b> 126 and 127 store the same texts. If desired, ask your sales representative to disable the menu item which you do not want to use.	
	<b>Header Text</b>	<b>Enter header texts</b>	Create New? # Existing items
	ID	Enter ID of the header text	1 ... 99'999'999
	Text	Enter header text	Max. 1500 characters
	<b>Footer Text</b>	Refer to "Header texts"	Refer to "Header texts"
	ID		
	Text		
	<b>Extra Text</b>		
	ID		
	Text		
<b>Branch Text</b>			
ID			
Text			
<b>127</b>	<b>Description by ID</b>	<b>Enter texts, organized by ID</b> Editing a text is the same as for 126.	
<b>128</b>	<b>Running Message</b>	Enter a multiline text for running display in the bottom line	Max. 300 characters



No.	Display	Description	Possible values
<b>129</b>	<b>Trace Info</b>	<b>Enter trace info</b>	
	Trace Type	Select type of the trace info ID	1 Public 2 Private
	Trace Info ID	Enter a reference identifier used in PLU, group or department; can be identical to the lot number	Max. 32 characters
	Short Code	Enter a short number by selection of a Trace Info ID, thus avoiding long lot numbers	Max. 8 characters
	Lot Number	Enter a unique identifier of the lot	Max. 32 characters
	Create Date	Enter the creation date of the lot number	1Jan2000...31Dec2027

No.	Display	Description	Possible values
<b>13 Price Management</b>			
<b>131</b>	<b>Discount</b>	<b>Define discounts</b>	Create New? # Existing discounts
	Discount ID	Enter discount ID	1 ... 99
	Discount Name	Enter discount name	Max. 32 characters
	Discount Value	Enter discount value	0 ... 100 (%) 1 ... 999999.99
	Discount Type	Select type of discount	1 Absolute 2 Percentage

No.	Display	Description	Possible values
<b>14 Payment</b>			
<b>141</b>	<b>Payment Method</b>	<b>Define up to 3 payment methods</b>	Create New? Existing methods
	Payment Method ID	Enter ID of the payment method	1 ... 99
	Payment Method Name	Enter name of the payment method	Max. 32 characters
	Payment Method Enable	Enable/disable payment method	Yes/No
	Need Change	Allow to change when the customer pays	Yes/No
	Allow Group in Printout	Allow group in printout	Yes/No
	All Refund	Allow refund	Yes/No
	Allow Top Up	Allow top up	Yes/No
	Allow Cancelling	Allow cancelling	1 Not Allowed 2 Allow Modify 3 Allow Delete 4 Allow Modify and Delete
	No. of Payment Times Limit	Enter number of payment times limit, e. g. you can pay 1 or 2 times	0 ... 99
	Amount Input Type	Select amount input type	1 Free Input 2 Limited Free Input 3 Fixed to Open Amount
	Default Amount	Select default amount	1 Open Amount 2 Zero
	Maximum Amount	Enter maximum amount	0 ... 999'999.99
	Minimum Amount	Enter minimum amount	0 ... 999'999.99
Driver	Select driver	1 None 2 RED Payment 3 Magnet Balance	
<b>142</b>	<b>Currency Library</b>	<b>Define a library of currencies</b>	Create New? Existing currencies
	Currency ID	Enter currency ID	1 ... 199
	Currency Name	Enter currency name	Max. 32 characters
	Currency Code	Enter currency code	3 characters, according to ISO definitions
	Currency Decimals	Select currency decimals	0...6
	Currency Resolution	Select currency resolution	0...1000000
	Exchange Rate	Enter exchange rate	0...999999
	Currency Symbol	Enter currency symbol	Max. 10 characters
	Currency Position	Select currency position	1 Prefix 2 Postfix

### 4.2.3 Configuration menu

In the Configuration menu you are able to enter the following data:

- Operation Center: configure operation (item recall, registration, tare, price, ...)
- General Settings: configure PLU, vendor, user management, ...
- Printing: configure printing
- Connectivity: configure connectivity
- Control Panel: configure settings of the control panel (display settings, power management, date and time, language, data storage)
- System: memory settings, reset of data base, reset of scale, ...

Some functions need not only to be enabled, but also need to have a key assigned to them, refer to 232. In the following, these functions are marked with a \*.

No.	Display	Description	Possible values
<b>21 Operation Center</b>			
<b>211</b>	<b>Item Recall</b>	<b>Define item recall</b>	
	Numeric Key Action	Select the method of calling up an item	1 None 2 Direct Price 3 PLU 4 Article Number
	Fractional Count	Enable/disable proportional calculation (price by count), e.g., when selling a half a melon	Enable/Disable
	Min Recall Key Counts	Number of characters for recalling the PLU	0 ... 8
	Allow PLU Type Switch	Enable/disable switching PLU type (by weight/by count). To switch the PLU, press the + key.	Enable/Disable
	Weight state for booking	Selecting the weight state between two bookings	1 None 2 Weight Changed 3 Back to min. Booking
	Source of PLU	Select data source for recalling PLUs	1 Local 2 Remote 3 Remote and Local
	Data Sync at Startup	When starting up the scale, synchronize the PLU data with the server	Enable/Disable
	PLU from Local Indicator	Enter address of a scale where to take PLU data from	max. 10 characters
	PLU from Server Indicator	Enter address of a server where to take PLU data from	max. 10 characters
	Recall Key Time Out	Timeout interval between pressing two keys	1 0 s 2 0.1 s ... 6 0.5 s
	PLU Number Relate Extra Text	Assign an extra text ID (which has the same value as the PLU ID) to the PLU.  The extra text ID in sub-menu 111 then has the lower priority.	1 Yes 2 No

No.	Display	Description	Possible values
211 con- tinued	Permanent Change Options	Allow permanent changes on the following items:	
		Switch PLU Type	1 Yes
		Label Nr	2 No
		Pack Date	
		SellBy	
		UseBy	
		ET Nr	
		Nutrition Nr	
212	<b>Item Registration</b>	<b>Define item registration</b>	
	Large Sales *	Enable/disable the large scale mode	Enable/Disable
	Suspend	Enable/disable suspending a ticket	Enable/Disable
	Void	Enable/disable voiding	Enable/Disable
	Refund	Enable/disable refunding	Enable/Disable
	Edit Sales Slip	Enable/disable editing the sales slip	Enable/Disable
	Fix After Booking	Select the method of fixing a PLU	1 By Option 2 By Fix Key
	Fix Option	Select which element is fixed when the FIX key is pressed	1 Tare Only 2 Tare and PLU 3 None
	Ticket print for each booking	Enable/disable ticket printing for each booking	Enable/Disable
	Record Weight For By Count Item	Enable/disable showing the weight for by count / piece articles	Enable/Disable
	Focus On PLU After Booking	Enable/disable returning to "Enter PLU number" after booking	Enable/Disable
213	<b>Tare</b>	<b>Define the tare method</b>	
	Manual Tare	Enable/disable manually entering of tare	Enable/Disable
	Platter Tare	Enable/disable entering of tare by weighing in an empty container	Enable/Disable
	Preset Tare	Enable/disable preset tare	Enable/Disable
	Customer Tare	Enable/disable customer tare / basket function	Enable/Disable
	PLU Preset Tare	Enable/disable PLU preset tare	Enable/Disable
	Multiple Preset Tare	Enable/disable multi preset tare (for adding several tare weights)	Enable/Disable
Primary Tare	Enter a tare value which will be used for all of your bookings	Depending on the scale capacity	

No.	Display	Description	Possible values
214 *	<b>Traceability</b> * availability depending on the country	<b>Define traceability record</b> <ul style="list-style-type: none"> <li>Trace Info IDs have to be uploaded with the PC Tool "Trace Manager"</li> <li>If traceability is mandatory for the item or department, the PLU can only be selected and used with a valid Trace Info ID</li> </ul>	
	Display Sort List	Select sorting criterion	1 Short Code 2 Lot Number 3 Date
	Default Selection	Use the first sort displayed	Enable/Disable
	Public Printout Option	Enable/disable public traceability	Enable/Disable
	Generate Short Code	Enable/disable generating the short code by the scale when storing the traceability record	Enable/Disable
	Sort Method	Select the sort method: FIFO: first in - first out LIFO: last in - first out	1 FIFO 2 LIFO
	Record QTY for each ID	<ul style="list-style-type: none"> <li>This number is used for defining the upper-limitation, how many traceability records can share one Trace Info ID</li> <li>Active only when the Traceability.SortMethod is set to FIFO or LIFO</li> </ul>	0...64
	TraceInfoID Auto Link	<p>When enabled, the PLU number is used as its Trace Info ID only during the booking to build the relationship between PLU and traceability record.</p> <p>When disabled, the PC tool needs to update the Trace Info ID in the PLU field to build the relationship.</p>	Enable/Disable
	PLU Traceability Mandatory	When enabled, an error message will pop up if we do not find a traceability record by the Trace Info ID. The process cannot go on.	Enable/Disable
Trace Select Input Type	Define what should be regarded as the input number, only for private trace select screen.	1 Short Code 2 Lot Number	

No.	Display	Description	Possible values
<b>215</b>	<b>Price</b>	<b>Define entering of the price</b>	
	Overwrite Unit Price *	Configuring price overwriting: either generally or depending on the PLU settings in sub-menu 231	1 Enable 2 Disable 3 Up to PLU
	Overwrite Total Price		
	Change to Other Price *	Enable/disable switching between the defined unit prices per PLU.  The price can only be changed to a price which has been defined in the scale for other PLUs.	Enable/Disable
	Direct price entry	Enable/disable direct price entry	Enable/Disable
	100g *	Enable/disable weighing with 100 g price unit	Enable/Disable
	Default Unit Price *	For PLUs with more than a single price, enable/disable switching between first and second (further) unit price	1 First Price 2 Second Price
	Change Price Permanently	Define how to change prices permanently	1 By Save As Key 2 Always
Direct Overwrite Price	Enable/disable direct overwriting of the price	Enable/Disable	
<b>217</b>	<b>Discount</b>	<b>Define discount method</b>	
	Discount on Unit Price	Enable/disable discount on the unit price	Enable/Disable
	Discount on Total Price	Enable/disable discount on the total price	Enable/Disable
	Discount on Sales Total	Enable/disable discount on the sales total	Enable/Disable
	Percent Discount	Enable/disable discount as a percentage	Enable/Disable
	Absolute Discount	Enable/disable discount as an absolute value	Enable/Disable
<b>218</b>	<b>Payment</b>	<b>Configure payment</b>	
	Reopen Ticket	Enable/disable reopening a ticket	Enable/Disable
	Multiple Payment	Enable/disable multiple payment methods	Enable/Disable
	Default Payment Method	Select default payment method	1 Cash # predefined payment objects
	Open Cash Drawer	Define the behavior of the cash drawer	1 No 2 Manual 3 Auto 4 Both
	Payment Closing	Define how to close payment	1 V key 2 Star key
<b>219</b>	<b>Others</b>	<b>Additional payment settings</b>	
	<b>Price Edit Log</b>	<b>Status:</b> Enable/disable price editing log file	Enable/Disable

No.	Display	Description	Possible values
<b>23 General Settings</b>			
<b>231</b>	<b>PLU Editing Fields</b>	<b>Configure PLU data</b>	
	Article Number	Switching article number on/off	On/Off
	Article Name #	Number of article names	1 None 2 Name 1 3 Name 1 + Name 2
	Number of Unit Prices	Number of unit prices	0 ... 5 (unit prices)
	Staggered Price Levels	Define number of staggered price levels	1 ... 99
	Group	Enabling/disabling working with article groups	On/Off
	Number of Categories	Enter number of article categories	1...5
	VAT	Switching VAT on/off	On/Off
	Preset Tare *	Defining which fields will show up in sub-menu 111 to create a PLU	On/Off
	Unit of Measures		
	Discount		
	Price Overwriting		
	Barcode		
	Extra Text		
	Number of Label Formats		
	Pack Date Print Flag	Define which fields will show up in sub-menu 111 to create a PLU	On/Off
	Pack Date Type		
	Use-By Print Flag		
	Use-By Date Type		
	Sell-By Print Flag		
	Sell-By Date Type		
	Fix Weight		On/Off
	Number of Images	Enter number of images	1...3
Trace Info ID	Switching trace info ID on/off	On/Off	
NutritionInformation ID	Switching nutrition infor ID on/off	On/Off	

No.	Display	Description	Possible values
<b>232</b>	<b>Function Key</b>	<b>Map the preset key to a function</b>	
	Key Mapping	<ul style="list-style-type: none"> <li>Select a function.</li> <li>Press the desired preset key until a beep is heard.</li> <li>For a preset key on the second level, press the desired preset key until a second beep is heard.</li> <li>When the function is mapped, the coordinates of the preset key are displayed, e.g., L3 C1 (Line 3, Column 1)</li> </ul>	
	Allow Preset Key Mapping	If set to No, the menu items cannot be mapped to the preset keys.	Yes/No
	Allow FN Key Mapping	If set to Yes, the function keys (e.g. the Menu key) can be mapped to another key.	Yes/No
<b>233</b>	<b>Vendor</b>	<b>Define the method of working with vendors</b> For creating a new vendor and defining vendor keys, refer to 121 and 232.	
	Vendor Mode	Select the vendor mode	1 Single Vendor 2 Multi Vendor 3 Floating vendor
	Number of Vendors	Number of vendors which can be activated on the scale	1 ... 10
	Vendor Key	Select the method of calling up the vendor	1 As V1 key 2 V + Vendor ID
	Vendor Group	Enter a name of the vendor group.	Max. 64 characters
	Vendor Auto Logout Time	Enter the time after which the vendor is logged out if there is no action on the scale by the vendor	0 .. 99999
<b>235</b>	<b>Licenses</b>	<b>Configuring options</b>	
	Input license	Input the license number. For more information on your options call your local sales representative.	
	Printout Licence State	Select to print licence state	
	Input LID	Enter licence ID	
<b>236</b>	<b>Training</b>	<b>Configuring training function</b> To call up the training function, a key has to be assigned in sub-menu 232.	1 Disable 2 by Vendor
<b>238</b>	<b>Change Domain Password</b>	<b>Changing passwords</b>	
	Access Domain 1	Change password for the selected access domain.	Old Password New Password Confirm New Password
	...		
	Access Domain 6	Using the ScaleManager software you can rename the access domain and allocate specific menu access	
	Reset by Default	Reset all domain passwords to default.	Yes/No



No.	Display	Description	Possible values
<b>24 Printing</b>			
<b>242</b>	<b>Printout Type</b>	<b>Select printout type</b>	1 Ticket 2 Label 3 Total label 4 Label + Total label
<b>243</b>	<b>Label configuration</b>	<b>Define label printing</b> For configuring the label content the software tool SmartLabel is available. Call your local sales representative.	
	Combination PLU	Print more than one PLU with a total on the label	Yes/No
	Copy Label	Print a copy of the label	Enable/Disable
	Unit Price Overwrite Indicator	Print an indicator on the label for Unit Price Overwrite	max. 10 characters
	Total Price Overwrite Indicator	Print an indicator on the label for Total Price Overwrite.	max. 10 characters
	Unit Price Discount Indicator	Print an indicator on the label for Unit Price Discount	max. 10 characters
	Total Price Discount indicator	Print an indicator on the label for Total Price discount.	max. 10 characters
	Upper Limit Total Label	Set the transaction quantity upper limit in order to make sure that all the transaction detail labels could be printed on the total label completely	5 ... 100
	Label for Sales by Weight	Select the label number for by-weight articles	1 ... 200
	Label for Sales by Count	Select the label number for by-count articles	1 ... 200
	Label for Pre-pack by Weight	Select the label number for by-weight articles in pre-packing	1 ... 200
	Label for Pre-pack by Count	Select the label number for by-count articles in pre-packing	1 ... 200
	Sub Total 1	Select the label number for subtotal 1	1 ... 200
	Sub Total 2	Select the label number for subtotal 2	1 ... 200
	Printout Direction	Select printout direction	1 0 2 180
	Customer Label Format Check	Check if the label format selected finally is customized or factory default	Enable/Disable

No.	Display	Description	Possible values
243 con- tinued	Label Format Size Check	<p><b>Ignore:</b> Print out the label of the PLU irrespective of the length of the real label in the printer.</p> <p>If the label format is longer than the real label, the exceeding part of the label is truncated.</p> <p>If the label format is shorter than the real label, feed a blank part and go to the beginning of the next label.</p> <p><b>Check for All Label:</b> Compare the length of all label formats for the recalled PLU to the real label. If matched, print out, otherwise show an error message .</p> <p><b>Select Suitable One:</b> Check the size of the item's PLU label formats and select the most suitable one for the current printout. If no suitable label format is found, show an error message; if more than one label is suitable, select the first one.</p>	<p>1 Ignore</p> <p>2 Check for all Label</p> <p>3 Select Suitable One</p>
	Batch Print Log	Select how to save transactions in the transaction log file for a batch	<p>1 Single</p> <p>2 Multiple</p>
	Batch Print for By Count	<p>Select how to print labels for batches of a by-count PLU</p> <p><b>Decided By Multiple Label Key:</b> The number of labels is set by pressing the [Multiple label] key.</p> <p><b>Continues Until Press Clear:</b> The scale will continue to print out labels until the Clear key is pressed.</p>	<p>1 Decided By Multiple Label Key</p> <p>2 Continues Until Quit</p>
	Zero Tare Print	Enable/disable printing of the tare value when it is zero	Enable/Disable
	Zero Days Mean	Indicate "Zero days mean" when the "sell-by date" and "use-by date" are described by day values	<p>1 Not Print</p> <p>2 Print Today</p>
	Barcode ID Origin	Select where the barcode ID comes from	<p>1 From PLU</p> <p>2 From Label Format</p>
	ITF25 Width	Select width of IFT25 barcode	<p>1 Narrow</p> <p>2 Wide</p>
	ITF25 Check Digit Type	Select ITF25 check digit type	<p>1 None</p> <p>2 Normal</p> <p>3 Reverse</p>
	Code 128 Check Digit Type	Select Code 128 check digit type	<p>1 None</p> <p>2 Normal</p> <p>3 Reverse</p> <p>4 TwoSegsChecksum</p>
	EAN13 Type	Select EAN13 type	<p>1 Normal</p> <p>2 Compact</p>
Code 128 Check Digit Include Alpha	When calculating the checksum include characters or not	<p>1 Not include</p> <p>2 Include</p>	

No.	Display	Description	Possible values
245	<b>Ticket configuration</b>	<b>Define ticket printing</b>	
	Direct Printout	Enable/disable direct printout of the ticket	Enable/Disable
	Ticket Duplication	Enable/disable automatic duplication of the ticket	Enable/Disable
	Copy Tickets	Setup printing of ticket copies	1 Autoprint 2 On Demand 3 No
	Talon	Setup printing a talon	1 Autoprint 2 On Demand 3 No
	Subtotal tickets	Printing subtotal tickets	Yes/No
	Ticket Bottom Feed Length	Set the length of the automatic paper feed after printing has finished	0 ... 100 (mm)
	Paper Feed Length	Set the length of a manual paper feed after printing has finished	0 ... 100 (mm)
Printer Printing Width	Configure the printing width	1 Fit to Printer Head 2 50 mm	

No.	Display	Description	Possible values
246	<b>Ticket content</b>	<b>Define ticket content</b> For comfortably configuring the ticket content the software tool SmartLabel is available. Call your local sales representative.	
	Ticket Number	Printing a ticket number on the ticket	Yes/No
	Date and Time	Printing date and time on the ticket	Yes/No
	Vendor Info	Printing vendor info on the ticket	Yes/No
	Scale Info	Printing scale info on the ticket	Yes/No
	Store info	Printing store info on the ticket	Yes/No
	Logo	Printing a logo on the ticket	Yes/No
	Header Text	Select a header text to print on the ticket	1 ... 99'999'999
	Footer Text	Select a footer text to print on the ticket	1 ... 99'999'999
	Nutrition Facts	Printing nutrition facts on the ticket	Yes/No
	VAT	Printing VAT on the ticket	Yes/No
	Void	Printing void on the ticket	Yes/No
	Change	Printing the change on the ticket	Yes/No
	Barcode	Select a barcode to print on the ticket	0...99
	Tare	Printing the tare weight on the ticket	Yes/No
	Original Price	Printing the original price on the ticket	Yes/No
	Rounding	Printing the rounded price on the ticket	Yes/No
	Total Savings	Printing total savings on the ticket	Yes/No
	Training information	Printing training information on the ticket	Yes/No
	Lot Number	Printing the lot number on the ticket	Yes/No
	Lot Number Barcode	Selecting the barcode for printing the lot number	0...99
	Booth Number	Printing the booth number	Yes/No
	Lot Number 1D Barcode Text	Printing the lot number ID barcode text	Yes/No
Ticket by Department	Printing tickets for each department separately	Enable/Disable	
Customer Credit Barcode	Printing a customer specific barcode	0...99	
Total Sales without Rounding	Printing the total sales value without rounding before printing the rounded value. If both values are the same, the total sales value without rounding will not be printed.	Yes/No	

No.	Display	Description	Possible values	
<b>25 Connectivity</b>				
<b>251</b>	<b>Network</b>	<b>Network settings</b>		
	IP Mode	Select IP mode	1 Automatic 2 Static	
	IP Address	Enter IP address		
	Mask	Enter mask		
	Gateway	Enter gateway		
	UDP Port	Enter UDP port	1 ... 65535	
	TCP Port	Enter TCP port	1 ... 65535	
<b>252</b>	<b>Wireless</b>	Configure the wireless network		
	Wifi Module Status		On/Off	
	Wifi Connection Type		1 Client 2 Access Point	
	AP SSID Name		max. 32 characters	
	AP Password		max. 64 characters	
	AP Security		1 None 2 WEP 3 WPA 4 WPA2	
	Connected to: SSID of connected network			
	Join Network	Automatic Join		On/Off
		Config. Type		1 Auto 2 Manual
		IP address		
		Subnet Mask		
		Gateway		
	Configure Network	SSID		max. 32 characters
		Security		1 None 2 WPA 3 WPA2
		Channel Width		
Password			max. 64 characters	

No.	Display	Description	Possible values
252 con- tinued	Advanced Parameters	MAC Address	
		Signal Strength in dB	
		Channel Selected	
		Channel Width	
		Speed in Mbps	
		Pair Mode	On/Off
		Restart Wifi Module	
		Factory Default Reset	
	<b>Wireless (Dolphin module)</b>		
	MAC Address		
	Reset to Default		
	IP Address		
	Subnet Mask		
	Gateway		
	SSID		max. 32 characters
	Network Type		1 Infrastructure 2 Ad-Hoc
	Encryption Type		1 Disable 2 WEP 3 WPA 4 WPA2
	Authentication		1 Open 2 Shared Key
	Key Length		1 Length 64 2 Length 128
	Key Format		1 HEX 2 ASCII
	WEP Encryption Key	if key length is 64 and key format is HEX, (two characters merge into one hex, e.g. 12ab = 0x12 0xab)	fix length: 10 characters
if key length is 64 and key format is ASCII		fix length: 5 characters	
if key length is 128 and key format is HEX		fix length: 26 characters	
if key length is 128 and key format is ASCII		fix length: 13 characters	
Cipher Suite		1 TKIP 2 AES	
WPA Encryption Key		8 ... 63 characters	

No.	Display	Description	Possible values
<b>256</b>	<b>Transaction Log Server</b>	<b>Define transaction log server</b>	
	Forwarding	Select the interval for forwarding the transaction log file	1 None 2 Immediate 3 Daily
	Service Type	Select the service type of forwarding	1 None 2 Forward Auto 3 Forward to IP 4 Server
	IP Address	Enter IP address	
	Domain Name	Enter domain name	max. 128 characters
	Port	Enter port	1...65535
	Overflow Action	Decide what to do when an overflow occurs	1 Delete Oldest 2 Block Booking
	Forward Now	Forward transaction log to the server	
<b>257</b>	<b>Data Server</b>	<b>Define data server</b>	
	Data Server Type	Select data server type	1 None 2 Retrieve Auto 3 Retrieve from IP 4 Server
	IP Address	Enter IP address	
	Domain Name	Enter domain name	max. 128 characters
	Port	Enter port number	
	Update to server	Only available if Data.Server Type is set to "Retrieve from IP" or "Retrieve Auto": Updating changes to the server	Enable/Disable
<b>259</b>	<b>Others</b>		
	Network Icon Behavior	Select behavior of the network icon	1 Identify Device 2 Data Server 3 Transaction Log Server 4 SARP server
	Customer Credit Server	Select the type of the customer credit server	1 Server 2 Client

No.	Display	Description	Possible values
<b>27 Control Panel</b>			
<b>271</b>	<b>Display</b>	<b>Set up display</b>	
	Idle	Set the standby display	1 Running message 2 Enter PLU
	Type	Select the type of display message	1 None 2 Date and Time 3 Running Message
	Speed	Select the speed of running message	1 Slow 2 Normal 3 Fast
	Waiting Time	Enter the time until the display changes to the standby mode	15 ... 300 Unit [s]

No.	Display	Description	Possible values
<b>272</b>	<b>Sound</b>	<b>Set up sound</b>	
	Beeper	Switch beeper on/off	On/Off
	Error Sound	Select frequency of the error sound	1 3951 Hz 2 3250 Hz
	Key Sound	Select frequency of the beeper when pressing a key	3 3136 Hz 4 ...
	Key Sound Config.	Select frequency of the beeper when configuring a key	
	Startup Sound	Select frequency of the beeper during start-up	1 4186 Hz 2 3951 Hz
	Shutdown Sound	Select frequency of the beeper during shutdown	3 3250 Hz 4 ...
<b>273</b>	<b>Power Management</b>	<b>Set up power management (Screensaver)</b>	
	Backlight Off Time	Select time after which the background lighting is turned off when there is no change in weight or no key is pressed.  The lower the setting, the longer the battery operation time.	1 Never 2 1 min 3 2 min 4 5 min 5 10 min
	Auto Off Time	Select time after which the sleep function is activated when there is no change in weight or no key is pressed.  The lower the setting, the longer the battery operation time.	1 Never 2 10 min 3 20 min 4 30 min 5 60 min
<b>274</b>	<b>Date and Time</b>	<b>Set date and time</b>	
	Date	Enter day, month, year in the displayed format	
	Time	Enter hours, minutes, seconds	
	Date Format	Select the date format	1 dd-MM-yyy 2 yyyy-MM-DD MM-dd-yyy
	Date Separator	Select the date separator	1 - 2 / 3 .
	Time Format	Select the time format	1 HH:mm:ss 2 hh:mm:ss tt
	First Day of Week	Select the first day of the week	1 Sunday 2 Monday
	Auto Synchronization		On/Off
<b>275</b>	<b>Language</b>	<b>Set display language</b>	
	Display Language	Select the display language	Languages depending on the product and the region
	Printout language	Select the printout language	
	Keyboard language	Select the keyboard language	



No.	Display	Description	Possible values
<b>28 System</b>			
<b>281</b>	<b>Memory</b>	<b>Memory settings</b>	
	Memory Usage	Select memory usage	1 Item 2 Event 3 Log
	Backup Trigger	Set up trigger for backup	1 None 2 Hibernate 3 Switch Off
	Backup Delay	Set delay of the start of the backup	1 1 min 2 5 min 3 10 min 4 40 min
	Backup Limit	Set backup limit	1 None 2 2 Hour 3 6 Hour 4 12 Hour 5 Daily 6 Weekly 7 Monthly
	USB Stick Restore Option	Select USB Stick Restore Option	1 Overwrite 2 Update 3 Demand
<b>282</b>	<b>Reset</b>	<b>Reset to factory settings</b>	
	Clear Database	Reset database	
	Factory Default	Reset scale to factory default settings	
	Ticket Start Number	Enter ticket start number to clear the database	1...99998
	Ticket End Number	Enter the ticket end number to clear the database	1...99999999
<b>283</b>	<b>Printout System Info</b>	<b>Print system information</b>	

#### 4.2.4 Reports menu

In the Reports menu group you are able to create the following reports:

- Single Reports: Sales Report, PLU Report, Vendor Report, ...
  - Combination Reports
  - Clear Period
- I**
- Assign keys in sub-menu 232 to call up your reports.
  - Using the ScaleManager software you can define and rename the Periods A to C.

No.	Display	Description	Possible values
<b>31 Single Reports</b>			
<b>311</b>	<b>Sales Report</b>	<b>Create a sales report</b>	
	Period Filter	Define the period of the report	1 Today 2 Period A 3 Period B 4 Period C
<b>312</b>	<b>PLU Report</b>	<b>Create a PLU report</b>	
	Period Filter	Define the period of the report	Refer to 311
	Data Filter	Define a data filter	1 All 2 By Range
	From	Report start number	0 ... 99'999'999
	To	Report end number	0 ... 99'999'999
	Sort By	Define if items are sorted by number or by amount	1 By Number 2 By Amount
	Order By	Define if items are sorted in ascending or descending order	1 Ascending 2 Descending
	Report Format	Define the type of the report	1 Simple 2 Detailed
<b>313</b>	<b>VAT Report</b>	<b>Create a VAT report</b>	
	Sort by	Define sorting method	Refer to 312
	Order By	Define if items are sorted in ascending or descending order	Refer to 312
<b>314</b>	<b>Vendor Report</b>	<b>Create a vendor report</b>	
	Period Filter	Refer to 312	Refer to 312
	Data Filter		
	From		
	To		
	Sort By		
	Order By		

No.	Display	Description	Possible values
<b>33 Combination Reports</b>			
<b>331</b>	<b>Daily</b>	<b>Create a daily combination report</b>	
	Sales report	Include sales report	Yes/No
	PLU report	Include PLU report	Yes/No
	VAT report	Include VAT report	Yes/No
	Group Report	Include group report	Yes/No
<b>332</b>	<b>Period A</b>	<b>Create a combination report for Period A</b>	
	Refer to "Daily"		
<b>333</b>	<b>Period B</b>	<b>Create a combination report for Period B</b>	
	Refer to "Daily"		
<b>334</b>	<b>Period C</b>	<b>Create a combination report for Period C</b>	
	Refer to "Daily"		
<b>335</b>	<b>Close Store</b>	<b>Closing reports</b>	
	Z Report	Select closing interval	1 Daily Closing 2 Weekly Closing 3 Monthly Closing 4 Yearly Closing
	Combination Report Period	Select combination report period	1 Today 2 Period A 3 Period B 4 Period C

No.	Display	Description	Possible values
<b>34 Clear Period</b>			
<b>341</b>	<b>Clear Period A</b>	<b>Clear the content of all reports for Period A</b>	Yes/No
<b>342</b>	<b>Clear Period B</b>	<b>Clear the content of all reports for Period B</b>	Yes/No
<b>343</b>	<b>Clear Period C</b>	<b>Clear the content of all reports for Period C</b>	Yes/No
<b>344</b>	<b>Clear All Periods</b>	<b>Clear the content of all reports for all periods</b>	Yes/No

No.	Display	Description	Possible values
<b>36 *</b>	<b>Z Report</b>	* Availability depending on the country	
<b>361</b>	Daily Closing	Execute Daily Closing	Yes/No
<b>363</b>	Monthly Closing	Execute Monthly Closing	Yes/No
<b>364</b>	Yearly Closing	Execute Yearly Closing	Yes/No
<b>365</b>	<b>Auto Closing Configuration</b>		
	Auto Daily Closing	Activate automatic Daily Closing	Yes/No
	Auto Monthly Closing	Activate automatic Monthly Closing	Yes/No

## 4.2.5 Mode menu

In the **Mode** menu you are able to select the operating mode and configure the pre-packing mode:

No.	Display	Description	Possible values
<b>41</b>	<b>Mode Selection</b>	<b>Select the operating mode</b>	1 Sales 2 Pre-pack
<b>42</b>	<b>Start Mode</b>	<b>Select the start mode</b>	1 Sales 2 Pre-pack 3 Last Mode
<b>43 Pre-packing Configuration</b>			
<b>431</b>	AutoPrint	Enable/disable the auto print (if weight is stable)	Enable Disable
<b>432</b>	Printout Type	Select the printout type	1 Ticket 2 Label 3 Total Label 4 Label + Total Label
<b>433</b>	Default Vendor	Enter vendor ID of the default vendor	1 ... 1000
<b>434</b>	Fix Default State	Select which item is fixed with the FIX key	1 Tare Only 2 Tare and PLU 3 None
<b>435</b>	Min Recall Key Counts	Enter number of characters for recalling the PLU	0 ... 8
<b>436</b>	Paper Type	Select paper type	1 Thermopaper 2 Label 3 Endless Label 4 Linerless 5 Linerless Black Bar

## 4.2.6 Advanced menu

In the *Advanced* menu you are able to specify scanner settings:

Data encoded in a barcode can be very long and complex for human reading and for manually inputting via the keyboard. A scanner can be used as an intermediary method to quickly transfer the data encoded in a barcode to the connected scale.

No.	Display	Description	Possible values
<b>51 Scanner</b>			
<b>511</b>	<b>Port Configuration</b>	<b>Define port configuration</b>	
	Scanner Status	Enable/disable scanner	Enable/Disable
	Port Type	Define port type If COM A or COM B is selected, the configuration of 511 will depend on the scanner. We recommend to use the USB port type.	1 COM A 2 COM B 3 USB
	Baud Rate	Define baud rate	1 4800 2 96000 3 19200 4 38400 5 115200
	Data Bits	Define data bits	1 7 Bits 2 8 Bits 3 9 Bits
	Stop Bits	Define stop bits	1 1 Bit 2 1.5 Bits 3 2 Bits
	Parity	Define parity	1 None 2 Odd 3 Even
<b>512</b>	<b>For Recall and Book</b>	<b>Define recall and book settings</b>	
	Item Recall Definition	Define item recall If "None" is selected, the scale will look at the information available in the "Barcode ID" menu, see below.	1 By PLU 2 By Article 3 Direct Price 4 None 5 Same as Numeric Key Action
	Barcode IDs	Barcode ID	0 ... 99
		Book Mode	1 Auto 2 Manual
		Vendor Key	1 Current Vendor 2 V1 3 V2 ... # Vendor max. Count
Default Book Mode	Define default book mode "Auto" will use the current vendor to book the scanned item. "Manual" will require a confirmation from the vendor to book the item.	1 Auto 2 Manual	

## 4.3 Configuration tips

### 4.3.1 Tips for setting up and configuring PLUs

#### Step 1: Configuring content of a PLU

In the factory setting, the whole extent of the PLU data fields is activated. In sub-menu 231, PLU data fields can be activated/deactivated.

#### Example

- Decide which date(s) you want to be printed on the label (Pack in, Sell By, Use By).
- Deactivate the Print Flag of the date(s) you do not want to be printed on the label.

#### Step 2: Editing lists

For many PLU items the scale offers lists to select from instead of entering the data directly when editing the PLU. To create lists, go to the following sub-menus:

- 115: Preset Tare
- 116: Barcode
- 126 / 127: Texts

#### Step 3: Traceability settings

When working with traceability, the following settings are necessary:

- 214: Define traceability record
- 111: Assign Trace Info ID to the PLU

### 4.3.2 Setting up vendor groups

 When you have different people working in different parts of your store, i.e. on different scales, you can set up vendor groups and create vendors in each group independently from the others.

Proceed as follows to set up vendor groups:

- 1 Decide on which scales the vendor group will work.
- 2 On each scale of the vendor group, go to sub-menu 233 and select "Vendor Group".
- 3 Enter the same vendor group name on each scale of the vendor group.
- 4 Go to sub-menu 121 and create vendors.
- 5 Leave the menu.

 Note the following when creating vendors in vendor groups:

- In each of the vendor groups you can start with Vendor ID = 1.
- Thus e.g. Vendor 1 in vendor group "ABC" and Vendor 1 in vendor group "XYZ" can be different persons.

### 4.3.3 Example for creating a PLU

**i** For operating the menu, refer to [Entering the menu ▶ Page 51].

- 1 Enter the menu and navigate to sub-menu 111 PLU Database/Edit.  
– or –  
Enter sub-menu number 111.
  - 2 Press the OK key.
  - 3 Use the Arrow up / Arrow down keys to select *Create New?* and confirm with the OK key.
  - 4 Select *Item Number* and confirm with the OK key.
  - 5 Enter an unused item number and confirm with the OK key.
  - 6 Use the Arrow up / Arrow down keys to step through the configured PLU items.
  - 7 Use the OK key to edit an item.
  - 8 Enter numerical values, e.g., price, and confirm with the OK key.
  - 9 Use the Arrow up / Arrow down keys to select from a list, e.g., units of measure, and confirm with the OK key.
  - 10 When all mandatory entries are made, press the Back key repeatedly until the normal selling display is shown.
- ⇒ All settings are saved automatically.

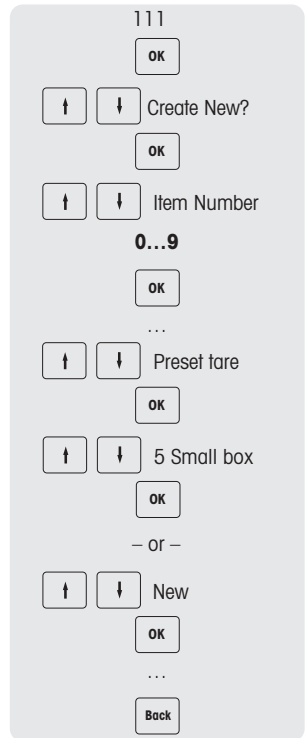

#### 4.3.4 Setting up a staggered price

- 1 Enter the menu and navigate to sub-menu F231 PLU Editing Fields.
- 2 Define the amount of stagger price levels, e.g., 3.  
⇒ The data fields will be automatically added in sub-menu F111 PLU Database/ Edit.
- 3 Navigate to sub-menu F111.
- 4 Press the OK key.
- 5 Use the arrow keys to select an existing PLU or "Create New?" and confirm with the OK key.
- 6 Navigate to "Limit above to 1" and press the OK key to edit the entry.
- 7 Define up to which weight / unit the first level price should be used (e.g., 1 kg) and confirm with the OK key.
- 8 Navigate to "Unit price staggered 1" and press OK to edit the entry.
- 9 Define the price which should be valid up to the first level (e.g., 1 kg is reached), and confirm with the OK key.
- 10 When all desired stagger price levels are entered, press the Back key repeatedly to return to the main menu / main screen.

The screenshot shows a vertical sequence of menu screens. At the top is 'F231' with an 'OK' button. Below it are two arrow buttons (up and down) and the text 'Staggered Price levels'. This is followed by another 'OK' button, a numeric input field showing '0...9', and another 'OK' button. The next screen shows 'F111' with an 'OK' button. Below that are two arrow buttons and the text 'Create New?'. This is followed by another 'OK' button, two arrow buttons, and the text 'Limit above to 1'. This is followed by an 'OK' button, a numeric input field showing '0...9', and another 'OK' button. The final screen shows two arrow buttons and the text 'Unit price staggered 1'. This is followed by an 'OK' button, a numeric input field showing '0...9', another 'OK' button, and finally a 'Back' button.



### 4.3.5 Setting up a barcode

**C** The barcode must first be defined in sub-menu 116.

#### 4.3.5.1 Configuring a barcode

- 1 Enter the menu and navigate to sub-menu 116 Barcode.
- 2 Press the OK key.
- 3 Use the arrow keys to select "Create New ?" and confirm with the OK key.
- 4 Select "Barcode ID" and confirm with the OK key.
- 5 Enter an unused barcode ID number and confirm with the OK key.  
⇒ The next available barcode ID number is shown as default.
- 6 Use the arrow keys to select "Barcode Name" and confirm with the OK key.
- 7 Define a name as reference with the keyboard for this barcode and confirm with the OK key.
- 8 Select "Barcode Type" and confirm with the OK key.
- 9 Use the arrow keys to select the desired barcode type and confirm with the OK key.  
⇒ Barcode type EAN 8 and EAN 13 from the GS1 standard are available.
- 10 Select "Barcode Format" and confirm with the OK key.
- 11 Use the keyboard to enter the placeholders, see table below.
- 12 Confirm with the OK key.
- 13 Press the Back key repeatedly to return to the main menu/main screen.

116

OK

↑ ↓ Create New?

OK

Barcode ID

OK

0...9 OK

↑ ↓ Barcode Name

OK

0...9 OK

↑ ↓ Barcode Type

OK

↑ ↓ EAN 8

OK

Barcode Format

OK

0...9 OK

Back

Content	Placeholder	Length
Scale ID	G	2-5
Vendor ID	O	2-4
PLU ID	P	4-8
Group ID	W	2-4
Department ID	F	2-4
Ticket ID	N	2-8
Current date	D	2 (YY), 4 (YYMM), 6 (YYMMDD)
Current time	J	2 (HH), 4 (HHMM), 6 (HHMMSS)
Counts of transaction	Q	2-4
Unit price	M	4-8
Total Price	B	4-7
Net/count	Q	4-6
Count/packages	Q	4-6
Item Number	A	4-13
Barcode Check digit	C	1
Parameter Check digit	C	1

### Examples

Barcode type	Configuration
Barcode EAN 8 with Ticket ID	NNNNNNNC
Barcode EAN 8 with Item Number	AAAAAAC
Barcode EAN 8 with Total price	BBBBBBBC
Barcode EAN 13 with Ticket ID + Vendor ID	NNNNNNNOOOOC
Barcode EAN 13 with Ticket ID + Total price	NNNNNNBBBBBC
Barcode EAN 13 with "flag" fix identifier (21) + Item Number + Total price	21AAAAABBBBBBC

### Assigning a barcode to a ticket

Once the barcode is defined, it needs to be assigned to the ticket.

- Only 1 barcode can be printed per ticket.
- If the barcode definition is wrong, no barcode will be printed. Please contact your service representative.

- 1 Enter the menu and navigate to sub-menu 246 Ticket Content.
- 2 Press the OK key.
- 3 Use the arrow keys to select "Barcode" and confirm with the OK key.
- 4 Enter the barcode ID number (reference) created before and confirm with the OK key.
- 5 Press the Back key to return to the main menu/main screen.

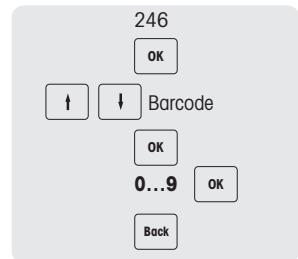

### 4.3.5.2 Multiple currency in a barcode

- 1 Go to menu 142 Currency Library.
- 2 Press the OK key to create a new currency.
- 3 For the new currency, make the following settings:
  - ⇒ **Currency ID:** press OK to confirm the ID displayed in scale.
  - ⇒ **Currency Name:** press OK to input the currency name, for example "Franc".
  - ⇒ **Currency Code:** press OK to input the currency code, for example, for Franc, it is "FRF".
  - ⇒ **Currency Decimals:** press OK to edit the number of decimals.
  - ⇒ **Currency Resolution:** press OK to edit the resolution..
  - ⇒ **Exchange Rate:** press OK to edit the exchange rate value.
  - ⇒ **Currency Symbol:** press OK to input the currency symbol.
  - ⇒ **Currency Position:** press OK and arrow up/down keys to select option "Prefix" or "Postfix".
- 4 Create a label format by PC tool with barcode ID 1.
- 5 Create a barcode ID 1.  
Barcode type : "Code 128" ,  
Barcode format:  $\$D(\text{ItemUAN} - I 6 - ju I)\$D(\text{TransactionTotalPrice} - I 6 - bu - cur FRF)\$D(\text{Checksum} - I \text{Normal})$

### 4.3.6 Label printing

#### Second label

**C** A second label is used to split the total content into 2 labels when the label content is larger than the actual label size. Therefore the following settings are necessary:

- In sub-menu 231 "Number of Label Formats" must be set to 2.
- For items in sub-menu 111 "Label IDs" must be set to "Label Format 1 and Label Format 2".

**i** Please note the following prerequisites:

- Proper label formats must be defined and transferred via PC tool.
- Only valid label formats will be printed out. E.g. if "Label Format 2" is set to 0 but "Label ID" = 0 is not defined, the second label will not be printed out.

#### Automatic printout of labels

**C** In pre-packing mode labels can be printed out automatically.

- In sub-menu 43 "Auto Print" must be enabled.

### 4.3.7 Setting up the keyboard

The keyboard (1) offers keys for custom assignment either as PLU preset keys or as function keys.

**bPlus-U2 / bPlus-C2**

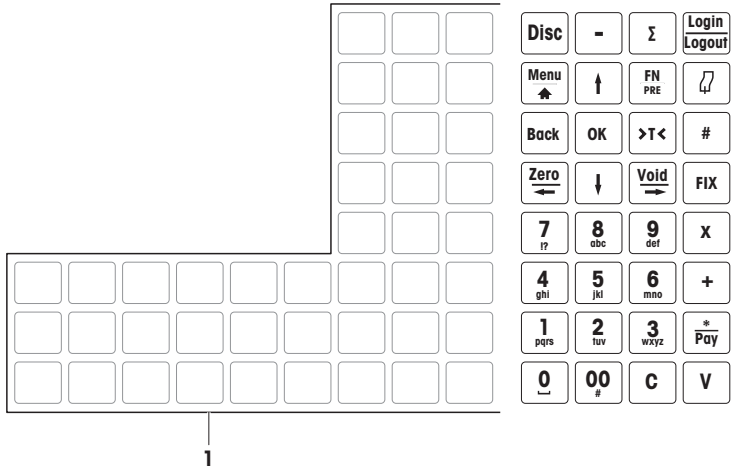

**bPlus-T2**

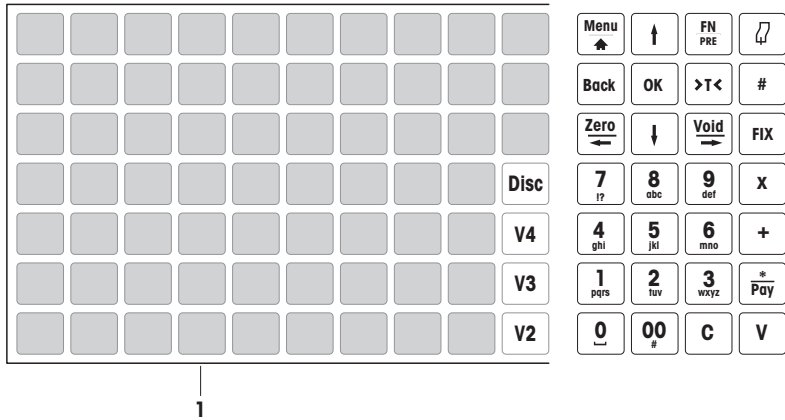

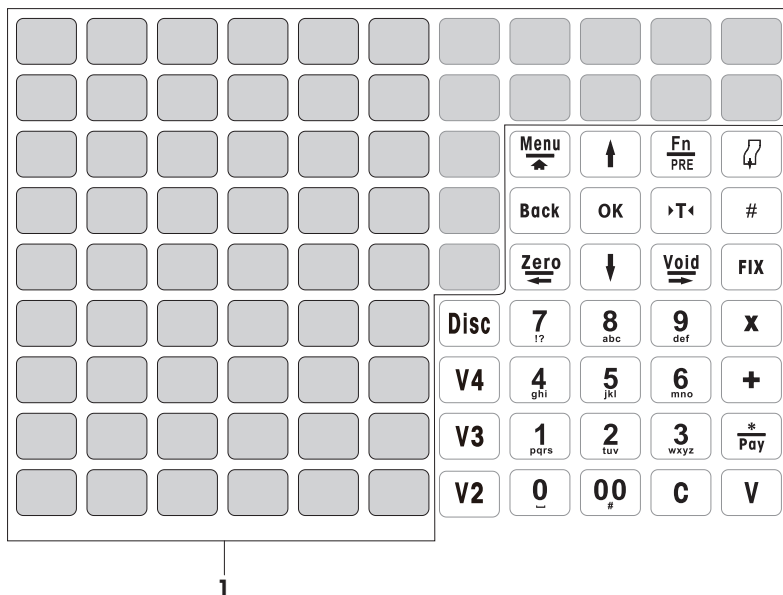

#### 4.3.7.1 Setting up PLU preset keys

**I** You can save the most important PLUs to the keys in the keyboard. The scale offers two layers of preset keys.

For information on how to create PLUs, see [Example for creating a PLU ▶ Page 85].

- 1 Enter the menu and navigate to sub-menu  
111 PLU Database/ Edit.
- 2 Press the OK key.
- 3 Use the arrow keys to select an existing PLU.  
– or –  
Recall PLU number.  
⇒ The unit price (per kg) and item name appear in the display.
- 4 Press the desired preset key until a beep is heard.  
⇒ The PLU has been assigned successfully to the preset key of the first layer.
- 5 To assign a PLU to the second layer, press the desired preset key until a second beep is heard.
- 6 Repeat steps 3 and 4 or 3 and 5 for further PLUs.
- 7 To leave the menu, press the Back key repeatedly until the normal selling display is shown.

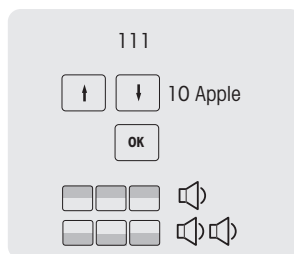

### 4.3.7.2 Setting up function keys

- You can assign the most frequently used functions to the keys on the keyboard.



- 1 Enter the menu and navigate to sub-menu 232 *Keymapping*.
- 2 Select a function.
- 3 Press the desired preset key until a beep is heard.
- 4 For a preset key on the second level, press the desired preset key until a second beep is heard.
- 5 When the function is mapped, the coordinates of the preset key are displayed, e.g., L3 C1 (Line 3, Column 1).

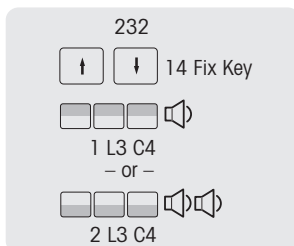

### 4.3.7.3 Setting up menu items on preset keys

- You can assign shortcuts for the most frequently used menu items to the keys on the keyboard.



- 1 Enter the menu and navigate to the desired sub-menu, e.g., 111 *PLU Database*.
- 2 Press the OK key.
- 3 Use the arrow keys to navigate to the desired sub-menu, e.g.,
- 4 Press the desired preset key until a beep is heard.  
⇒ The PLU is assigned to the preset key of the first layer.
- 5 For further menu items, repeat steps 3-4.
- 6 Press the Back key repeatedly to return to the main menu / main screen.

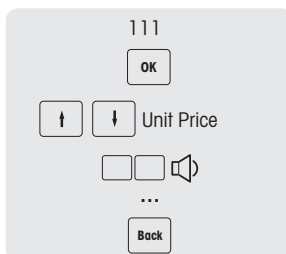

### 4.3.8 Setting up a scale network with data synchronization

- You can set up different network types depending on your needs, e.g. with or without data synchronization.

**I** The following example shows how to set up a scale network with data synchronization at start up of the scale. For this option, you will define one scale as "Data Server / Master" (where the data are managed) and the other scales as "Client" (where the data will be recalled from).

#### Configuring the "Data Server/Master" scale

- Make the following settings on the "Data Server/Master" scale:

Menu	Sub-menu	Setting	Remark
251 Network	IP-Mode	Automatic	The scales are in the same network and can communicate with each other.
257 Data Server	Data Server Type	Server	The scale acts as server
211 Item Recall	Source of PLU	Local	The PLUs are stored and managed on this scale
	Data Synch at Start up	Disabled	No data synchronization

#### Configuring the "Client" scale

- You need to configure each client scale individually.

**I**

- Make the following settings on all the "Client" scales:

Menu	Sub-menu	Setting	Remark
251 Network	IP-Mode	Automatic	The scales are in the same network and can communicate with each other.
257 Data Server	Data Server Type	Retrieve Auto	The scale acts as client and may retrieve data from a server.
211 Item Recall	Source of PLU	Remote + Local	PLUs can be retrieved from the server and managed locally.
	Data Synch at Start up	Enable	The data will be synchronized at start up of the scale.

- Restart the client scale/s in order to synchronize the item data, e.g. vendor, group etc., with the "Data Server/Master" scale.

### 4.3.9 Connecting the scale to a network or a computer

For connecting the scale to a network or a computer, please contact your local sales representative.

### 4.3.10 Setting up reports

#### 4.3.10.1 Setting up basic reports



- Basic reports are based on 4 counters which are summing up the quantity for different information: "Sales Report", "PLU Report", "Department Report" etc..
- All reports can be available for 4 time periods: "Today", "Period A", "Period B" and "Period C".
- The daily report (e.g., "Today") will be shifted to yesterday when the date changes. It will always be empty in the morning when starting the scales. In order to ensure correct data for all time periods ("Today", "Period A", "Period B", "Period C"), the corresponding report types cannot be deleted.

#### Example

- 1 Enter the menu and navigate to sub-menu  
31 Basic Reports.
- 2 Select the report you would like to set up / print out, e.g., 311 Sales Report.
- 3 Set "Period Filter" to "Today".
- 4 Print out a report at the end of the day and repeat printout the entire week.
- 5 At the end of the week, navigate to the sub-menu 311 Sales Report.
- 6 Set "Period Filter" to e.g. "Period A".  
⇒ The turnover of the entire week will be printed.
- 7 Delete the report only once a week.

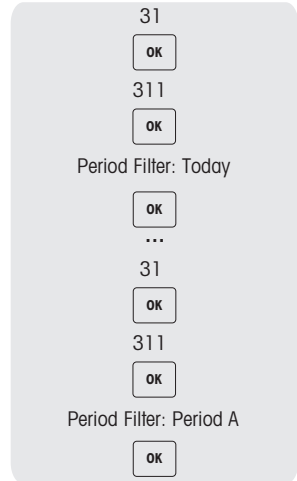

- As long as all scales are in the network and running, the report printed on one scale will include the data from all other scales in the network.
- If one scale in the network is switched off, the data from this scale will not be taken into account in the report.
- Deleting the report will not delete the Sales Journal. Deleting the Sales Journal will not delete the report counters.



### 4.3.10.2 Setting up combination reports

**I** Combination reports allow you to print several reports at once. You can define the content of the combination report in sub-menu 33.

- 1 Enter the menu and navigate to sub-menu 33 *Combination Report*.
- 2 Use the arrow keys to navigate to the required report type.
- 3 Select / deselect a report type and confirm with the OK key.
- 4 To add more report types, repeat steps 2-3.  
⇒ All reports set to "Yes" will be part of the combination report.
- 5 To print the combination report, press the Star key.  
– or –  
Define a preset key in menu 232 and initiate the print-out via keyboard.

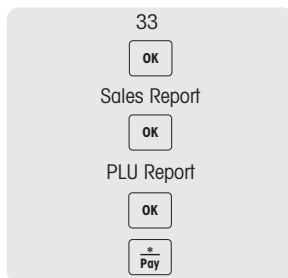

**I** The time period of each report is defined in its respective sub-menu. It is therefore possible to have different time periods in the combination report, e.g., a "Sales Report" of "Today" and a "PLU Report" "Since last Deletion".

### 4.3.10.3 Sales journal

The sales journal represents a scale's list of activities. It is the daily total ticket – typically what the vendor uses to close the day.

**I** The data used on the sales journal is completely independent from the data used in the reports. Furthermore, the data used in the sales journal is completely independent from the data used for fiscalization, which is saved on the fiscal memory. Deletion is also independent from data on the sales journal and data from the report.

**C** Sales journal enabled in sub-menu F35.

There are two different versions of sales journals:

- The simple sales journal is a sum-up of the tickets.
- The detailed sales journal is composed of PLU details per ticket.

- 1 Enter the menu and navigate to sub-menu F35.
- 2 Select the sales journal you want to print: the simple or the detailed sales journal.
- 3 Press the [Print] key.
- 4 Reconfirm if you want to print the selected sales journal.

⇒ The sales journal is printed and all data are deleted afterwards.

**I**

- Ensure that you store the printed sales journal carefully as it will automatically be deleted after printing. This is to avoid having mismatch in the printed information with wrong or double printed sales journals leading to wrong sum up at the end.
- Once the journal has been printed, it will erase the memory and create free space to save new data. Therefore, it is strongly recommended to print the sales journal regularly if the functionality is enabled.
- In order not to lose any information about transactions, memory will not be erased until the sales journal has been printed. If the journal is never printed, the scale will block the storing of transactions until the journal has been printed.
- The scale will inform the user regularly if memory is getting limited. The scale will not allow any new transaction when the memory is 100 % full.
- For users not using sales journal, it is strongly recommended to disable this function to prevent the scale from blocking the storage of new transactions.

### 4.3.11 Setting up scale mode

Your scale allows operation both in pre-pack mode and in sales mode. The factory setting in sub-menu 41 is pre-pack mode.

#### Sales mode features

- Totalizing items using the Star key [\*].

#### Pre-pack mode features

- Automatic printout after each weighing
- Label printing
- Default vendor - so you do not have to enter your vendor password all the time
- Fixing tare or fixing both tare and PLU for several weighings

These features can be configured in sub-menu 43.

#### Configuring pre-pack mode

- 1 In menu 43 make the following settings:
  - ⇒ **Auto Print**: define whether the scale will print automatically after loading weight for by-weight PLUs.
  - ⇒ **Print Type**: define the print type
  - ⇒ **Default Vendor**: define the vendor ID for booking and printing
  - ⇒ **Fix Default State**: to control which need to fix in prepack mode
  - ⇒ **Min Recall Key Counts PLU**: define minimum number of key counts for recalling the PLU in pre-pack mode
  - ⇒ **Paper Type**: defined which paper type to use.
- 2 Quit the menu

#### Operation in pre-pack mode

- 1 Long press FN/PRE key to enter pre-pack mode.
- 2 Recall a by-weight PLU.
  - ⇒ Place the item on the scale, the label will be printed automatically.
- 3 Recall a by-count PLU.
  - ⇒ Input the number of items and press the Vendor key to print the label.

#### Switching scale mode

- If enabled, the scale mode can be switched using the Pre-pack key.

### 4.3.12 Training function

Training transactions are marked on the label and there is a separate training report.

#### Training label

**METTLER TOLEDO**

Training

**Farm-Raised Catfish**

SELL BY: 10/18/13 **\*\*TOTAL PRICE\*\***

NET WT. <b>1.00 LB</b>	UNIT PRICE <b>\$9.99</b>	<b>\$9.99</b>
---------------------------	-----------------------------	---------------

Product of the U.S. [www.mt.com/retail-labels](http://www.mt.com/retail-labels)

**SAFE HANDLING INSTRUCTIONS**

This product was prepared from inspected and graded meat and/or poultry. Some food products may contain bacteria that could cause illness if the product is mishandled or cooked improperly. For your protection, please follow safe handling instructions.

- Keep refrigerated or frozen. Thaw in refrigerator or microwave. Keep covered and separate from other foods. Wash working surfaces containing raw poultry, seafood, and eggs after handling raw meat or poultry.
- Do not thaw again.
- Keep all foods hot. Hot spots kill most bacteria, but do not.

MT334

## 5 What to do, if ...?

In case of an operating error, the error message will be displayed for approx. 1 second in the bottom line of the display. Error messages can be cleared with the C key.

No.	Message	Description / – Remedy
1	Operation denied	<ul style="list-style-type: none"> <li>Defined preconditions for operation are not met</li> <li>System configuration / user rights are not setup to perform the requested action</li> <li>System currently in a status where the operation is not allowed</li> </ul>
2	Tare not allowed	<ul style="list-style-type: none"> <li>The weight must be bigger than 0.000 kg and not exceed the max. allowed value</li> </ul>
3	Weight not stable	<ul style="list-style-type: none"> <li>Outside conditions like vibrations or wind can prevent the system from displaying the right weight value</li> </ul>
5	Print transactions	<ul style="list-style-type: none"> <li>To switch working modes or reopen a ticket all recorded sales transactions need to be printed or must be suspended</li> </ul>
6	Item not found	<ul style="list-style-type: none"> <li>Item not found in the database, temporarily locked or out of stock</li> </ul>
7	Memory full	– Clear the memory to continue work
8	Tare not found	<ul style="list-style-type: none"> <li>Tare number not found and cannot be recalled</li> </ul>
9	Paper empty	– Insert a new label roll
10	Ticket not found	<ul style="list-style-type: none"> <li>Ticket number not found in the memory</li> </ul>
11	Vendor not active	<ul style="list-style-type: none"> <li>Login</li> <li>When the vendor was working on another device which is not reachable anymore, go back to this device</li> </ul>
12	Negative weight	<ul style="list-style-type: none"> <li>The displayed weight must not be less than 0.000 kg when working with by-weight PLUs</li> </ul>
13	Weigh again	<ul style="list-style-type: none"> <li>After transactions the weight needs to be lifted off the weighing pan</li> </ul>
14	Weight too large	<ul style="list-style-type: none"> <li>The weight exceeds the weighing capacity of the scale</li> </ul>
15	No data	<ul style="list-style-type: none"> <li>A sales record can only be recorded if a PLU was recalled or an item price entered manually</li> </ul>
16	Negative item price	<ul style="list-style-type: none"> <li>Negative item prices are not supported</li> </ul>
17	Weight too small	<ul style="list-style-type: none"> <li>Printing below 20 e not supported</li> <li>– Check if the weighing pan is being lifted through external influences</li> </ul>
19	Count limits	– Enter a valid value for by-count articles (1 ... 9999)
20	Invalid input	<ul style="list-style-type: none"> <li>Value not permitted or exceeding size limit</li> </ul>
21	List entry not found	<ul style="list-style-type: none"> <li>List entry not found</li> </ul>
22	Enter amount	– Enter the amount given by the customer
27	Unknown error	<ul style="list-style-type: none"> <li>No detailed description available</li> </ul>
28	Void denied	<ul style="list-style-type: none"> <li>Void operation could not be processed by credit card reader.</li> <li>– Try again.</li> </ul>
29	All keys used	<ul style="list-style-type: none"> <li>All defined Vendor keys currently used by other vendors</li> </ul>
30	Password not correct	– Reenter the correct password
31	Power failure	<ul style="list-style-type: none"> <li>AC power is not stable or battery is running low</li> <li>The system will shut down automatically</li> </ul>
32	Network failure	<ul style="list-style-type: none"> <li>Network connection cannot be established</li> <li>Data transmission in the network is constantly or temporarily blocked</li> <li>– Check cable connections or wireless connections</li> </ul>

No.	Message	• Description / – Remedy
33	Scanner not found	• Communication to the scanner can not be established
34	Barcode denied	• Barcode format not supported • Barcode cannot be read
35	Open transactions	• When shutting down, the system detected not printed or suspended transactions
36	Vendor not identified	– Identify yourself by pressing your Vendor key
37	Remove weight	– Remove the weight from the weighing pan when starting up
38	Suspend memory full	– Recall at least one suspended transaction before suspending another sales transaction
40	Value out of range	– Enter a smaller or bigger value
42	Old tare deleted	• There have been too many tare values recorded. The oldest tare value was deleted to store the most recent tare value
44	Traceability data missing	• Booking operation denied because traceability data is missing
45	Over weight limit	• The weight is larger than the limitation of the traceability information
46	Close cash drawer	– Close the cash drawer
47	Payment not complete	– Finish payment
48	Preset tare not defined	– Define preset tares
49	ticket not found	• ticket number could not be found in the log file
50	Total or unit price not defined	– Start transaction again from the beginning
51	Memory achieving size limits	• About 85% of the assigned memory is full – To avoid blocking of the system, enter configuration mode and choose the preferred backup method
52	Ticket not close	– Close or suspend the ticket
53	Take goods up and down again	• Movement on the weighing pan not below the minimum booking weight since the last booking – Lift off the weighing goods and put them down again
54	weight below purchase lower limit	– Increase weight
55	Exceed upper limit of weight	– Reduce weight
56	Precious goods	– Weigh precious goods on a high resolution scale
57	Paper not taken up	– Take off the label
58	Label too short	• The labels of the inserted label roll are too small to print the complete label – Replace label roll by a suitable one
59	No customized label format	– Download customized label formats
60	Enter the Refund Mode first	• You are trying to open a refund ticket – Enter the refund mode
61	100 g not supported	• Unit price cannot be divided by 10, e.g., 2.95 – For the 100 g function only use unit prices which can be divided by 10, e.g., 2.90
62	No label format	• Invalid label format for the current label

No.	Message	Description / – Remedy
63	Error in label format	<ul style="list-style-type: none"> <li>The label format for the current label is faulty</li> </ul>
64	Printer head too hot	– Wait until the printer head has cooled down
65	Printer head is copy version	– Replace the printer head by an authorized edition
66	ET not found	<ul style="list-style-type: none"> <li>No link to the ET (extra text) number in the database</li> </ul>
67	Date is invalid	– Enter a valid date in the displayed format
68	Time is invalid	– Enter a valid time in the displayed format
69	Vendor not found	<ul style="list-style-type: none"> <li>The vendor with the entered ID does not exist</li> </ul>
70	Vendor login other key	– Vendor already logged in with another key
71	Trace is not found	<ul style="list-style-type: none"> <li>Traceability record not found</li> </ul>
72	Print type not matching	<ul style="list-style-type: none"> <li>The print type of the current ticket does not match the current print type of the scale</li> </ul>
73	Over transaction limit	<ul style="list-style-type: none"> <li>Transaction quantity has exceeded upper limit</li> </ul>
74	Server is failure	<ul style="list-style-type: none"> <li>Data remote server unreachable</li> </ul>
75	Server is inactive	<ul style="list-style-type: none"> <li>Data remote server inactive</li> </ul>
77	Power off	<ul style="list-style-type: none"> <li>Ensure that the printed is powered and switched on</li> </ul>
79	Printer Busy	– Wait
80	Enclosure open	– Close the printer cover
81	Time-out	– Press the key again to print
82	Wrong password	– Enter correct password
83	Password not correct	– Enter correct password
84	Label size not appropriate	<ul style="list-style-type: none"> <li>Label height and paper height are not matching</li> </ul>
85	Connection Error Server / USB Device	– Connect and try again
87	Scale memory reached 50 %	– Insert a USB device or connect to a server to avoid transaction blocking
88	Scale memory reached 75 %	– Insert a USB device or connect to a server to avoid transaction blocking
89	Scale memory reached 90 %	– Insert a USB device or connect to a server to avoid transaction blocking
90	Ticket Number cannot be used	<ul style="list-style-type: none"> <li>Ticket number already exists</li> <li>Ticket counter might have reached limits</li> <li>Export or upload old tickets</li> </ul>
91	Direct Price Not Allowed	<ul style="list-style-type: none"> <li>Direct Price is not allowed in inventory function</li> </ul>
92	Open transaction already exists	<ul style="list-style-type: none"> <li>Cannot open the ticket from the list as already an open ticket exists</li> </ul>
95	No open ticket	<ul style="list-style-type: none"> <li>No open ticket to display for the Vendor key pressed</li> </ul>
96	DB is full	<ul style="list-style-type: none"> <li>Databases is full</li> </ul>
97	UB device not found	– Insert the USB storage device to support backup of data
98	Press Calibration Button	– Press the calibration button to enter the menu. Otherwise you cannot do any modification.

No.	Message	Description / – Remedy
99	Primary key already used	<ul style="list-style-type: none"> <li>Primary key is already used by another item</li> </ul>
100	Menu not found	<ul style="list-style-type: none"> <li>Menu number entered does not exist</li> </ul>
101	Value not valid	<ul style="list-style-type: none"> <li>Data format or value not in the defined range</li> </ul>
102	Report Error - DB full	<ul style="list-style-type: none"> <li>Error updating reports</li> <li>Database memory might be full</li> </ul>
103	Too many scales on the network	<ul style="list-style-type: none"> <li>Reduce number of scales in the network</li> </ul>
104	Local Export and/or Forwarding must be On Demand	<ul style="list-style-type: none"> <li>Set "Fiscalization" or "Forwarding to "On Demand".</li> </ul>
106	Battery Failure	<ul style="list-style-type: none"> <li>Backup battery failure</li> </ul>
107	Exceed Zero Range	<ul style="list-style-type: none"> <li>Reduce weight before zeroing</li> </ul>
108	Printer Link Abnormal	<ul style="list-style-type: none"> <li>Print Link Abnormal</li> </ul>
109	Some booked goods can't apply member price	<ul style="list-style-type: none"> <li>Member price not available for the booked item.</li> </ul>
110	Please enter valid top-up amount	<ul style="list-style-type: none"> <li>Enter a valid top-up amount</li> </ul>
111	Current Vendor already have verified member	<ul style="list-style-type: none"> <li>The member has already been verified by the current vendor</li> </ul>
112	Top-up ticket is open	<ul style="list-style-type: none"> <li>Close top-up ticket before accessing any other ticket</li> </ul>
114	Invalid lot number barcode type	<ul style="list-style-type: none"> <li>The barcode cannot be used for lot number barcode printing</li> </ul>
115	Restricted Input	<ul style="list-style-type: none"> <li>Input entry is restricted</li> </ul>
117	Ticket Locked	<ul style="list-style-type: none"> <li>Ticket locked</li> <li>Please pay in the same scale</li> </ul>
118	The trace record is invalid	<ul style="list-style-type: none"> <li>The mandatory fields for trace record is invalid</li> </ul>
119	This vendor is fixed to other V keys	<ul style="list-style-type: none"> <li>This vendor is fixed to other V keys</li> </ul>
121	No current vendor in scale	<ul style="list-style-type: none"> <li>No current vendor logged in</li> </ul>
123	The Vendor key is not available	<ul style="list-style-type: none"> <li>The Vendor key is not available</li> </ul>
124	Print the refund ticket	<ul style="list-style-type: none"> <li>Cannot add positive price sales transaction to refund ticket</li> <li>Please print the refund ticket first</li> </ul>
125	Ticket is Locked in Scale No.:	<ul style="list-style-type: none"> <li>The requested ticket is locked in the scale No. #</li> </ul>
127	Foreign currency not defined	<ul style="list-style-type: none"> <li>There is no foreign currency available in the scale</li> </ul>
128	Invalid currency code	<ul style="list-style-type: none"> <li>Enter a valid currency code with 3 characters</li> </ul>
131	System parameter error detected	<ul style="list-style-type: none"> <li>System parameter error detected</li> </ul>

No.	Message	Description / – Remedy
135	DB soon full - no new items	<ul style="list-style-type: none"> <li>The item database will soon be full</li> <li>– Stop creating new items in the scale</li> </ul>
136	Operation denied - DB Full soon	<ul style="list-style-type: none"> <li>Operation denied because the item database is almost full</li> </ul>
137	Operation denied - DB Full	<ul style="list-style-type: none"> <li>Operation denied because the item database is completely full</li> </ul>
140	Fatal Error in DB. Try restarting the scale.	<ul style="list-style-type: none"> <li>Fatal error in the databases</li> <li>– Try restarting the scale</li> </ul>
142	Driver is disabled	<ul style="list-style-type: none"> <li>Connection failed because the driver is disabled</li> </ul>
143	Unable to update the password	<ul style="list-style-type: none"> <li>The value provided by the new password does not meet the history requirements of this domain</li> </ul>
144	Password already used	<ul style="list-style-type: none"> <li>The value provided by the new password is already used by others</li> </ul>
145	Unable to update the password	<ul style="list-style-type: none"> <li>The password you entered does not match</li> </ul>
146	Unable to update the password	<ul style="list-style-type: none"> <li>The password cannot be set as Null</li> </ul>
147	No wireless module detected	<ul style="list-style-type: none"> <li>No wireless modules installed</li> <li>Wireless module temporarily not accessible (currently restarting)</li> </ul>
148	Access right denied	<ul style="list-style-type: none"> <li>No access rights for the current vendor</li> </ul>
149	Enter the Sales Mode first	<ul style="list-style-type: none"> <li>You are trying to open a sales ticket</li> <li>– Enter the sales mode first</li> </ul>
150	Please print vendor[s] transaction	<ul style="list-style-type: none"> <li>– Please print the open transaction by Vendor key</li> </ul>
151	Please print the open total label first	<ul style="list-style-type: none"> <li>Cannot add sales transaction to rewrap ticket</li> <li>– Print the rewrap ticket first</li> </ul>
152	No Nutrition Object	<ul style="list-style-type: none"> <li>There is no nutrition information with this ID</li> </ul>
158	No Files Exist	<ul style="list-style-type: none"> <li>No files exist</li> </ul>
159	Voided ticket do not need to reopen	<ul style="list-style-type: none"> <li>You do not need to reopen a voided ticket</li> </ul>
161	Communication Error	<ul style="list-style-type: none"> <li>Communication error</li> </ul>
164	Different measurement metric is not supported in one scale	<ul style="list-style-type: none"> <li>Different measurement metric is not supported on one scale</li> </ul>
168	Empty Ticket	<ul style="list-style-type: none"> <li>Order ticket has only voided transactions</li> </ul>
169	Service information is not configured	<ul style="list-style-type: none"> <li>Service information is not configured</li> </ul>
171	Invalid Department Number	<ul style="list-style-type: none"> <li>You are trying to book an item that does not belong to the current scale's department</li> </ul>
172	Total price is hidden	<ul style="list-style-type: none"> <li>Total price is hidden</li> <li>– Please confirm unit price</li> </ul>
180	Please clear PLU before zero operation	<ul style="list-style-type: none"> <li>– Please clear the PLU before zeroing</li> </ul>
181	Connection Error	<ul style="list-style-type: none"> <li>Error in connecting to the server</li> </ul>



No.	Message	• Description / – Remedy
184	No Updates Available	<ul style="list-style-type: none"> <li>• No updates available</li> </ul>
185	Keyboard Error	<ul style="list-style-type: none"> <li>• Malfunction of the keyboard detected</li> <li>– Make sure to operate the scale in a dry environment</li> </ul>

## 6 Technical data



The available capacities depend on the country.

### 6.1 bPlus-U2

#### Scale data

3 / 6 kg dual interval, e = 1 / 2 g, minimum load 20 g  
6 / 15 kg dual interval, e = 2 / 5 g, minimum load 40 g  
15 / 30 kg dual interval, e = 5 / 10 g, minimum load 100 g  
12 kg, e = 2 g, minimum load 40 g

#### Customer and operator displays

Weight display 6 digits  
Tare 5 digits  
Unit price display 6 digits  
Total price 7 digits  
Text line 16 alphanumeric characters  
Display type 1 line dot Matrix

#### Ambient conditions

Operating temperature -10°C to +40°C  
Storage temperature -10°C to +50°C  
Humidity 85% RH, non-condensating

#### Electrical data

Mains connection 100–240 V AC, 50 / 60 Hz  
Standby power consumption < 0.5 W  
Working power efficiency > 85 %

## 6.2 bPlus-C2

### Scale data

3 / 6 kg dual interval, e = 1 / 2 g, minimum load 20 g  
6 / 15 kg dual interval, e = 2 / 5 g, minimum load 40 g  
15 / 30 kg dual interval, e = 5 / 10 g, minimum load 100 g

### Customer and operator displays

Weight display	6 digits
Tare	5 digits
Unit price display	6 digits
Total price	7 digits
Text line	16 alphanumeric characters
Display type	1 line dot Matrix

### Ambient conditions

Operating temperature	-10°C to +40°C
Storage temperature	-10°C to +50°C
Humidity	85% RH, non-condensating

### Electrical data

Mains connection	100–240 V AC, 50 / 60 Hz
Standby power consumption	< 0.5 W
Working power efficiency	> 85 %

## 6.3 bPlus-T2

### Scale data

3 / 6 kg dual interval, e = 1 / 2 g, maximum load 6 kg  
6 / 15 kg dual interval, e = 2 / 5 g, maximum load 15 kg  
15 / 30 kg dual interval, e = 5 / 10 g, maximum load 30 kg

### Display

Weight display 6 digits  
Unit price display 6 digits  
Total price 7 digits  
Tare 5 digits  
Display type 1 line dot Matrix or segment display

### Ambient conditions

Operating temperature -10°C to +40°C  
Storage temperature -10°C to +50°C  
Humidity 85% RH, non-condensating

### Electrical data

Mains connection 100–240 V AC, 50 / 60 Hz, 1.6 A

## 6.4 bPlus-H2

### Scale data

6 / 15 kg dual interval, e = 2 / 5 g, maximum load 15 kg  
15 / 30 kg dual interval, e = 5 / 10 g, maximum load 30 kg

### Display

Weight display 6 digits  
Unit price display 6 digits  
Total price 7 digits  
Tare 5 digits  
Display type 1 line dot Matrix

### Ambient conditions

Operating temperature -10°C to +40°C  
Storage temperature -10°C to +50°C  
Humidity 85% RH, non-condensating

### Electrical data

Mains connection 100–240 V AC, 50 / 60 Hz, 1.6 A

### Suspension

Length 223 mm  
Outer diameter 36 mm  
Screw hole diameter 8 x 7 mm

## 6.5 Compliance

Compliance to the following standards is indicated by the corresponding mark on the product.

This product conforms to the EMC directive 2014/30/EC, the Low Voltage Directive 2014/35/EC and the Non-automatic Weighing Instruments Directive 2014/31/EC. The complete Declaration of Conformity is available online at

<http://www.mt.com/retail-manuals>



## 6.6 Options/Accessories



If you would like to add an option/accessory to your scale, please contact your sales representative.





[www.mt.com/retail](http://www.mt.com/retail)

For more information

**Mettler-Toledo GmbH**

Im Langacher 44  
8606 Greifensee, Switzerland  
[www.mt.com/contact](http://www.mt.com/contact)

Subject to technical changes.  
© Mettler-Toledo GmbH 08/2018  
30500123G en



30500123